



HydraPure

2½ inch Residential UV System

Owner's Manual



Contents

- Overview.....3
- Installation.....3
- Operation.....8

HYDRAPURE



Pool, Spa & Pond
Water Sanitizer 4BJ1



EPA Registered
#084221-AZ-001

**REGISTER
NOW**
to extend your
WARRANTY

see back of manual for details

Hayward Industries
400 Connell Drive, Suite 6100
Berkeley Heights, NJ 07922
Phone: (908) 355-7995
www.hayward.com



HAYWARD®

IMPORTANT SAFETY INSTRUCTIONS

When using this electrical equipment, basic safety precautions should always be followed, including the following:

- **READ AND FOLLOW ALL INSTRUCTIONS**
- **WARNING:** Follow all applicable electrical codes.
- **WARNING:** Turn off power at main source before making any electrical connections or servicing the unit.
- **WARNING:** To reduce the risk of electric shock, injury or death disconnect unit from power supply.
- **WARNING:** Follow the instructions or risk of serious injury or death could occur!
- **WARNING:** To reduce risk of injury, do not permit children to use this product unless they are closely supervised at all times.
- **WARNING:** Risk of electric shock. Install at least 5 feet (1.5m) from inside wall of pool, hot tub or spa using nonmetallic plumbing.
- **WARNING:** This product shall only be connected to a power supply receptacle protected by a ground fault circuit interrupter.
- **DANGER:** Replace damaged cord immediately.
- **DANGER:** Do not bury cord.
- **DANGER:** Connect to a grounded, grounding type receptacle only.

UV EXPOSURE & PROTECTION: V-A and UV-B radiation can have adverse short and long term effects on the eyes and skin. Never look directly at a UV lamp that is connected to a power source. Avoid UV skin exposure at all times.

SAVE THESE INSTRUCTIONS

Signal Words and Symbols Used In This Manual

This Owner's Manual and Installation Guide contains specific precautions and symbols to identify safety-related information. You will find DANGER, CAUTION, WARNING and NOTICE symbols which require special attention. Please read them carefully and follow these precautions as indicated! They will explain how to avoid hazards that may endanger you or persons using or maintaining your pool or spa.



HAYWARD®

PLEASE REVIEW THE OWNER'S MANUAL AND INSTALLATION GUIDE IN ITS ENTIRETY AND HEED ALL SAFETY INFORMATION. Failure to follow these instructions and warnings can result in DEATH OR SERIOUS INJURY.

- **DANGER:** Indicates a hazardous situation which, if not avoided, will result in death or serious injury.
- **CAUTION:** Indicates a hazardous situation which, if not avoided, could result in minor or moderate injury.
- **WARNING:** Indicates a hazardous situation which, if not avoided, could result in death or serious injury.
- **NOTICE:** Is used to address practices not related to physical injury.

SAVE THESE IMPORTANT SAFETY INSTRUCTIONS

For the most current version of this install manual go to:
www.hayward.com

READ AND FOLLOW ALL IMPORTANT SAFETY INSTRUCTIONS

When installing and using this electrical equipment, basic safety precautions should always be followed, including the following: This product should be installed by a professional service technician or similar person who is qualified in electrical equipment installation. Improper installation and/or operation could cause serious personal injury, property damage or death. Improper installation and/or operation will void the warranty.

The device must be connected only to a supply circuit that is protected by a Ground Fault Circuit Interrupter (GFCI). FAILURE TO CONNECT THIS DEVICE TO A GFCI SUPPLY CIRCUIT COULD RESULT IN ELECTRICAL SHOCK CAUSING SERIOUS BODILY INJURY, INCLUDING DEATH. Disconnect all AC power before installation and servicing. To prevent possible fire or electrical shock, use only replacement lamp specified by the manufacturer. A bonding lug is provided on the external surface. To reduce the risk of electric shock, connect the local common bonding grid in the area of the swimming pool, spa, or hot tub to these terminals with an insulated or bare copper conductor not smaller than 8 AWG US / 6 AWG Canada. Replace damaged cords immediately. Lamps and quartz sleeves are made of glass and are extremely delicate. Care should be taken when handling or replacing these components.

This device is for swimming pool use only. Do not use this device for potable (drinking) water sanitization. Use of this product in applications other than swimming pools and spas will void your warranty and could be harmful to your health or the health of others.

CAUTION : ULTRAVIOLET RADIATION. Disconnect power before replacing lamp(s).

This device contains ultraviolet lamps that can cause discomfort, irritation, and damage to the eyes if viewing occurs while device is in operation. Prolonged exposure to the eyes can cause serious injury including blindness. DO NOT VIEW UV LAMP WHILE THE DEVICE IS IN OPERATION.



HAYWARD®

Overview

Specifications

Plumbing diameter: 2½" unions

Input power (corded model): 120VAC, 50Hz/60Hz

Input power (hardwired model): 120VAC, 50Hz/60Hz or 240VAC, 50Hz/60Hz

Power consumption: 151 Watts; or 1.26A, 120 VAC; 0.66A, 230VAC

Maximum operating pressure: 50 psi

Operating flow range: 10-120 gpm

Maximum flow rate: 120 gpm

99.9% sanitization flow rate maximum: 80 gpm

Sizing

The HydraPure is capable of sanitizing residential pools up to 60,000 gallons. For larger installations, more than one HydraPure can be used. When using multiple HydraPure units, plumb vessels in parallel.

Tools Needed

Saw or PVC pipe cutter

PVC glue

Phillips head screwdriver

Installation

Before starting your installation, you **MUST** read this manual in its entirety in order to install your unit in a safe manner. Note that a few moments spent becoming familiar with the HydraPure unit and its installation may save a great deal of time (and expense) later. If you have any questions that are unanswered when you have completed the reading of this manual, contact your supplier or Hayward. Installation of HydraPure requires mounting, plumbing, installing a venturi and flow switch (on the return side of the filter pump), and connecting the required electrical connection. Disconnect power to the pool filter pump before starting this installation. Installation must be performed in accordance with local and NEC code.

Determine a Suitable Location

The HydraPure must be mounted at least 5' from the pool (more, if local codes require). The HydraPure should be installed after all equipment (pump, filter, heater) but prior to any chlorinators (salt cell, tablet feeder, liquid injection).



HAYWARD®

Head Loss

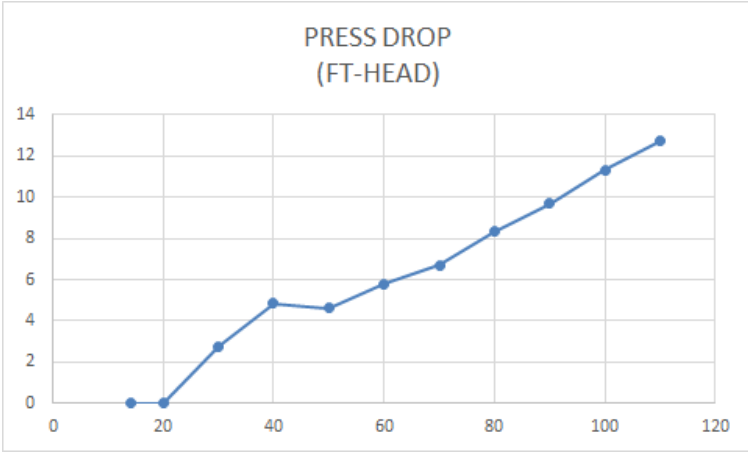

Plumbing Overview

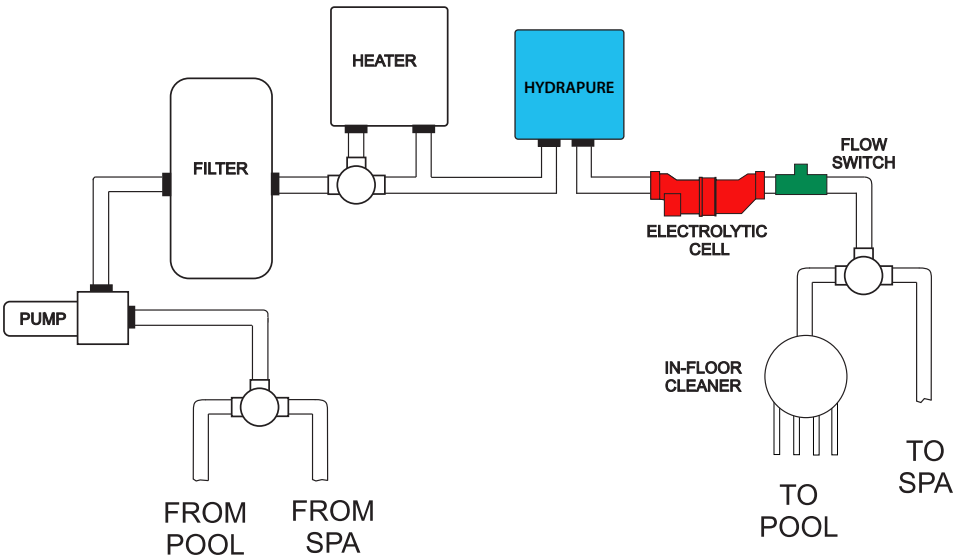



HAYWARD®

Plumbing the HydraPure Unit

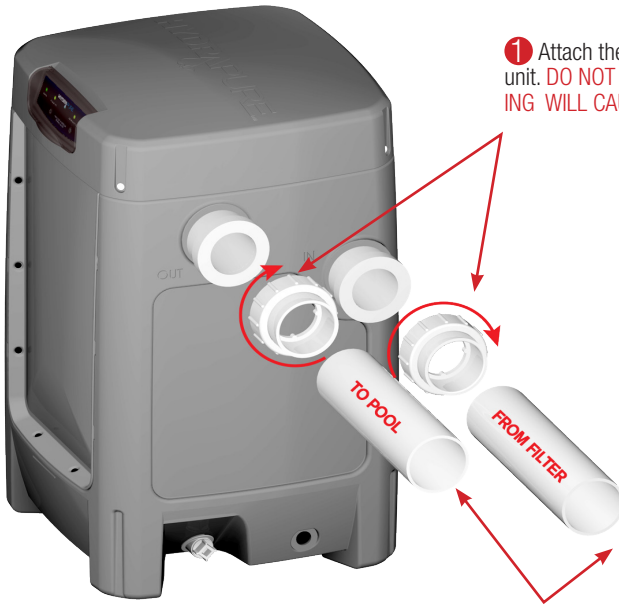

① Attach the (2) PVC 2½" union nuts to the unit. **DO NOT OVER TIGHTEN, OVER TIGHTENING WILL CAUSE THE UNIONS TO BREAK.**

② After cutting pipes to length, debur all cut pipe to ensure shavings don't plug critical points internal to the unit. Use PVC solvent cement to glue pipes into the union sleeve. NOTE the inlet and outlet pipe positions.

2" X 2½" reducer bushings may be used if using 2" pipe.

Connecting Power to the HydraPure Unit

Corded 120V Hydrapure unit: Plug into GFCI outlet.

Hardwired 120V or 240V Hydrapure unit: Follow steps 1 & 2 below.

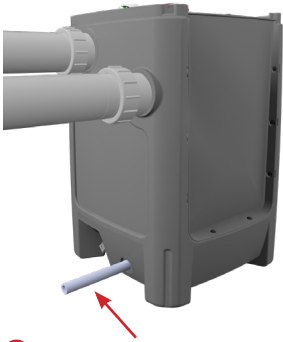

- 1 Thread L1, L2 (240V) or N (120V) and ground wire through conduit.

- 2 Attach wires to connections according to diagram below.

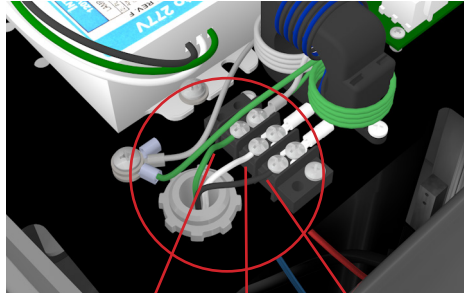

Position the Hydrapure Lid

The lid can be positioned in any four directions for better view of the control panel.

- 1 Remove the 4 screws and then carefully lift the lid.



- 2 Rotate the lid and replace it in the desired position. Replace the 4 screws.



CAUTION: Be aware that there is a delicate control ribbon cable under the lid. Take care when handling.



HAYWARD®

In some cases it may be necessary to use an alternate Ozone check valve. This prevents the Hydrapure unit from losing pump prime and draining down the equipment set. This would be necessary when the Hydrapure Unit is positioned with the base of the unit greater than 1' above water level. In that case the inlet check valve must be changed based on the chart below.

Base of Hydrapure to water level	Check Valve Rating	Part Number
1' or Lower	1.0 LB	005-402-2505-00
1'-3' (30cm-90cm)	2.0 LB	005-402-2506-00
3'-5' (90cm-150cm)	3.0 LB	005-401-2503-00
5'-8' (150cm-240cm)	4.0 LB	005-401-2504-00

In order to change the Ozone check valve, the installer simply loosens and unscrews the tubing compression fitting, loosen and unscrew the Check valve from the venturi Inlet connection. Warning: Be sure to shutoff the equipment before removing anything from the unit, and drain the unit using the winterizing plug. There may be water present in the Venturi if the unit has been cycled on.

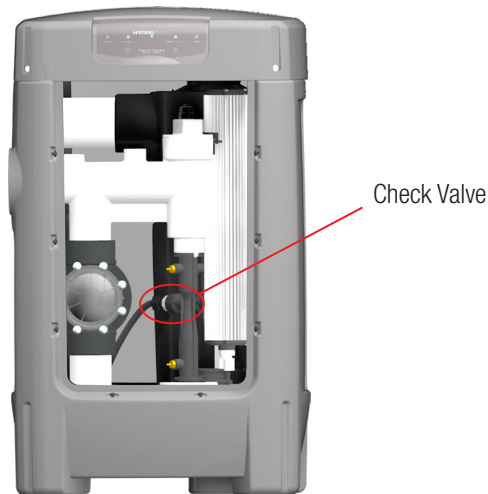

Startup

1. Turn on the pool pump and verify that there are no leaks. If there are no leaks turn off pump and proceed to step 2.
2. Turn on power to the HydraPure by turning on the breaker or plugging it in.
3. Turn on the pool pump, the HydraPure will switch on automatically when it senses water flow.



Operation



No lights on unit is off



Green POWER light indicates power to unit



Green FLOW light indicates proper water flow into unit



Green UV BULB LIFE & OZONE BULB LIGHT indicates all bulbs and unit functioning properly



Green or red flashing UV BULB LIFE indicates UV bulb is nearing end of lifespan and will need replacing soon, see page 12



Green or red flashing OZONE BULB LIFE indicates ozone bulb is nearing end of lifespan and will need replacing soon, see page 13



Red flashing UV BULB LIFE indicates UV bulb is no longer sanitizing and should be replaced soon, see page 12

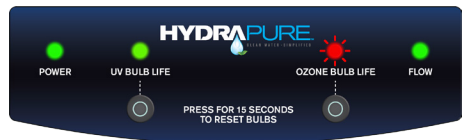

Red flashing OZONE BULB LIFE indicates ozone bulb no longer producing ozone and should be replaced soon, see page 13



Solid red UV BULB LIFE indicates malfunction with UV bulb and should be replaced immediately, see page 12

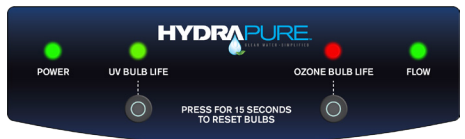

Solid red OZONE BULB LIFE indicates malfunction with ozone bulb and should be replaced immediately, see page 13

Maintenance

The quartz tube requires cleaning every 12 months to ensure optimal performance.

WARNING: Before cleaning, turn off all power to the HydraPure unit and pool pump. Allow at least 15 minutes for the lamp(s) in the unit to cool. Never remove the electrical enclosure cover without first disconnecting the power source from the HydraPure unit. Never remove the HydraPure unit's cover without turning off the pump. Before removing lamps, you must wear protective rubber gloves and safety eye wear. Do not handle a hot lamp or serious burns will occur.

1 Turn Off Power to unit or unplug.

2 Remove screws to lid.

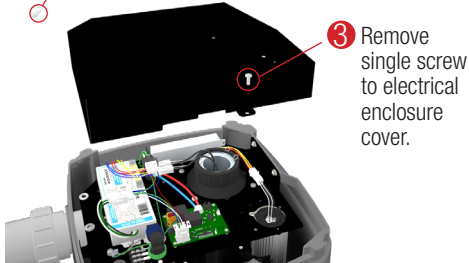
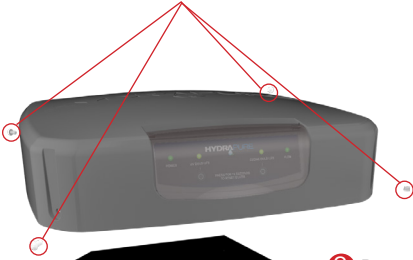

4 Disconnect UV lamps from ballast.

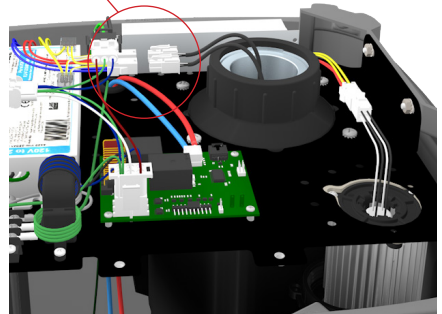

5 Remove spring clip.





HAYWARD®

- 6 Carefully lift the lamp assembly, including lamp holder, do not pull excessively on the lamp wires.

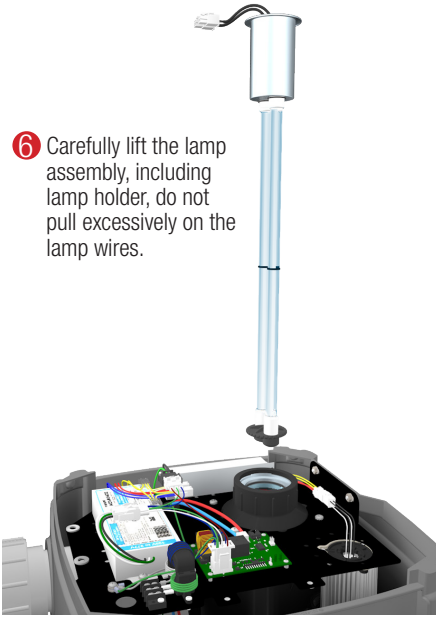

- 7 Turning counter-clockwise, unscrew the round sealing nut.



- 8 Remove the aluminum compression washer making sure not to lose the black gasket.

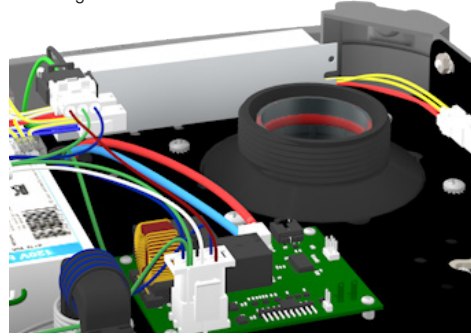
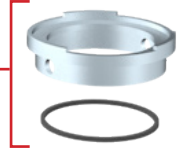

NOTICE: Do not touch the glass part of the lamp as body oils will create hot spots & greatly shorten lamp life. Inspect the quartz tube carefully for any cracks or chips and replace the quartz tube if any are found. Do not use any other O-ring for sealing the quartz tube. Never use any type of lube or sealing agent. Doing so can result in a leak and possibly damaging the UV unit.

- 9 Grip quartz tube with both thumbs inside and pull up. Once the O-ring breaks free, the quartz tube should lift out easily.

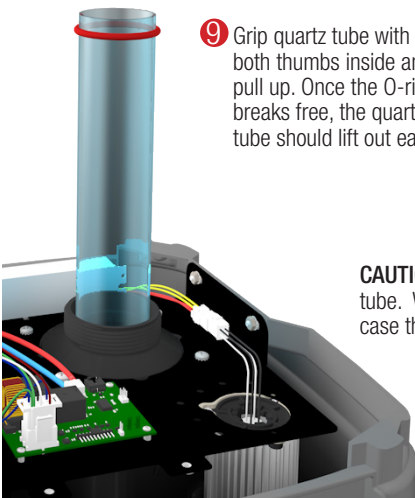

- 10 First, remove O-ring and discard. Use shower/tub cleaner, CLR or equivalent, or a solution of white vinegar and water to clean the outside/inside of the quartz tube. The quartz tube must be completely dried and clear of residue, replace with new O-ring before reassembly.

CAUTION: Do not use tools on the quartz tube. Wear gloves to protect your hands in case the tube breaks.



HAYWARD®

Press down evenly

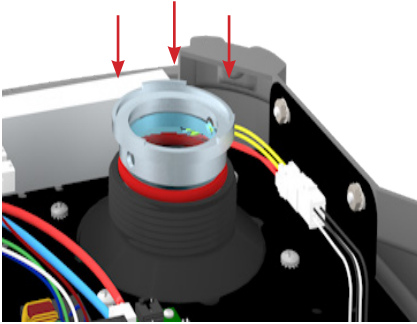

- 11 Gently lower the quartz tube into the unit until the O-ring makes contact with the top of the black threaded sealing sleeve. Then place the aluminum compression washer and gasket on the quartz tube. Press down on the aluminum compression washer with an even steady pressure. Lift aluminum washer and check to make sure it is seated evenly around the circumference of the quartz tube. Replace aluminum washer.

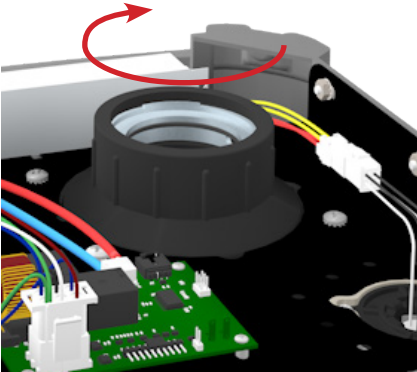

- 12 Screw on the quartz sealing nut to hand tight plus $\frac{1}{2}$ turn. Turn pump on to check for leaks.

Confirm that there are no leaks then turn off pump.

Carefully replace lamps, spring clip and connect lamps to ballast.

Reattach electronics cover and the lid. Turn power on to unit and turn pump on.

CAUTION: Do not stand over the unit when it is under pressure or when the pump is on.

UV Lamps Replacement

WARNING: Turn off all power to the HydraPure unit and pool pump. Before proceeding allow at least 15 minutes for the lamp(s) in the unit to cool. Never remove the electrical enclosure cover without first disconnecting the power source from the HydraPure unit. Never remove the HydraPure unit's cover without turning off the pump. Before removing lamps, you must wear protective rubber gloves and safety eye wear. Do not handle a hot lamp or serious burns will occur.

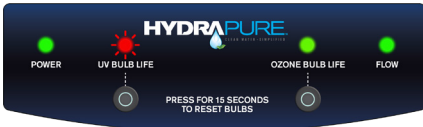

Red flashing UV BULB LIFE indicates UV bulb is no longer sanitizing and should be replaced soon,

1 Turn Off Power to unit or unplug.

2 Remove screws to lid.



3 Remove single screw to electrical enclosure cover.

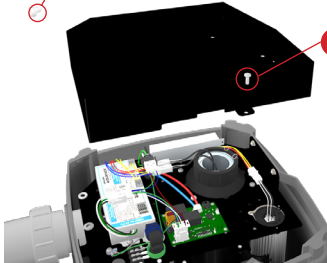

4 Disconnect UV lamps from ballast.

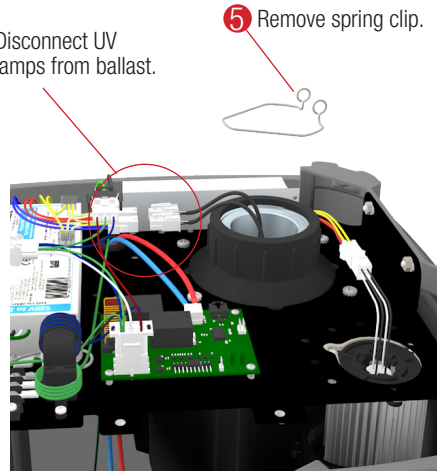

5 Remove spring clip.



HAYWARD®

- 6 Carefully lift the lamp assembly, including lamp holder, do not pull excessively on the lamp wires.

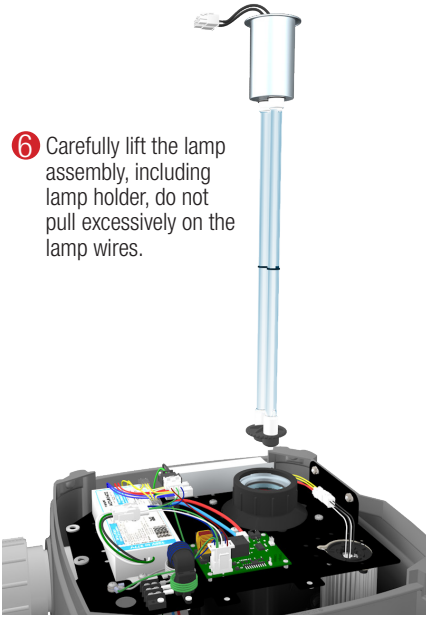

- 7 Insert lamps into lamp holder. Lamps must be aligned and seated securely in the lamp holder. Roll the black O-rings up onto the ceramic end of lamp from position A to B.

- 8 Gently insert lamps into the lower lamp retainer and lower lamp assembly into unit. Re-install the spring clip and re-attach the lamp connectors to the ballast.

- 9 After power is restored, press and hold UV BULB LIFE Button, for a minimum of 15 seconds, to reset the lamp life indicator.

Discard lamp(s) appropriately. Visit www.lampcycle.org for instructions on disposal.

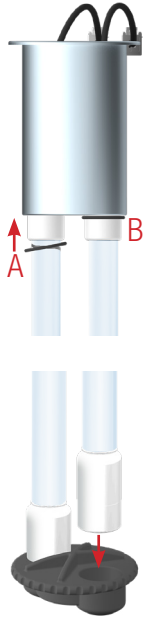

Ozone Lamps Replacement

WARNING: Turn off all power to the HydraPure unit and pool pump. Before proceeding allow at least 15 minutes for the lamp(s) in the unit to cool. Never remove the electrical enclosure cover without first disconnecting the power source from the HydraPure unit. Never remove the HydraPure unit's cover without turning off the pump. Before removing lamps, you must wear protective rubber gloves and safety eye wear. Do not handle a hot lamp or serious burns will occur.

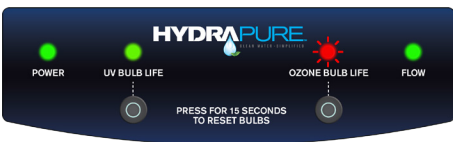

Red flashing OZONE BULB LIFE indicates ozone bulb no longer producing ozone and should be replaced soon.



HAYWARD®

1 Turn Off Power to unit or unplug.

2 Remove screws to lid.

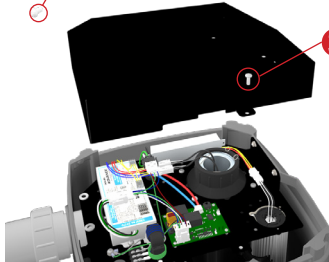

3 Remove single screw to electrical enclosure cover.

4 Disconnect ozone lamp from ballast.

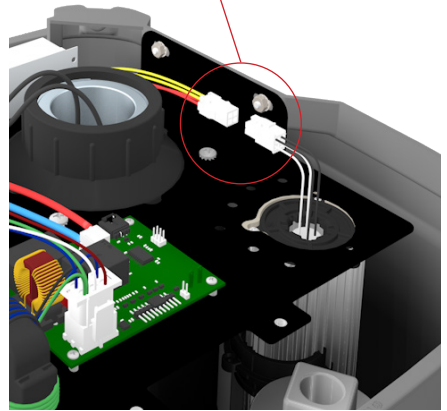

5 Carefully lift the lamp assembly, a slight tug may be necessary to loosen the lamp from the lamp retention fingers.

6 Insert lamps into lamp holder. lamps must be aligned and seated securely in the lamp holder.

7 After power is restored, press and hold OZONE BULB LIFE Button, for a minimum of 15 seconds, to reset the lamp life indicator.

Discard lamp(s) appropriately.
Visit www.lamprecycle.org for instructions on disposal.

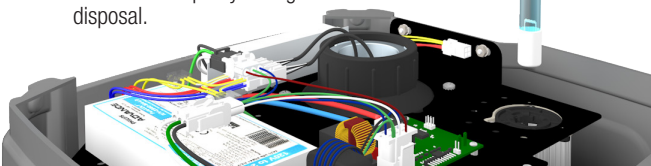



HAYWARD®

Winterizing

WARNING: Turn off all power to the HydraPure unit and pool pump before proceeding to winterize.



Remove Winterizing O-ring plug near the bottom of the unit. Note, there will be an initial rush of water from the unit after the plug is removed. Allow unit to completely drain, this will take 1-2 minutes. Re-install O-ring plug hand tight.



HAYWARD®

This page intentionally blank



HAYWARD®

This page intentionally blank



HAYWARD®

This page intentionally blank

90 DAY EXTENDED WARRANTY* REGISTER WITH YOUR SMARTPHONE

— PROTECT YOUR INVESTMENT IN 2 EASY STEPS —

1. TAKE A PHOTO

Take a photo of the camera icon

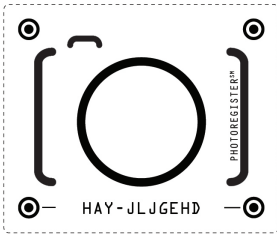

2. SEND IT IN

Send it in using one of the methods below



SMARTPHONE

Text a photo of the camera icon to **71403**

OR



ONLINE

Visit Hayward.com/Warranty

OR



MESSENGER

Send photo to **photoregister**

*Extended warranty is in addition to applicable product warranty and is for parts only, labor not included.

Need help? Visit photoregister.com/help or text HELP to 71403.

For further information or consumer
technical support, visit our website at
www.hayward.com



HAYWARD®



Hayward is a registered trademark
of Hayward Industries, Inc. © 2020 Hayward Industries, Inc.

All other trademarks not owned by Hayward are the property of their respective owners.
Hayward is not in any way affiliated with or endorsed by those third parties.

USE ONLY HAYWARD GENUINE REPLACEMENT PARTS