

# SALUSPA®

**Bestway**

# CONTENTS

---

<b>IMPORTANT SAFETY INSTRUCTIONS</b>	<b>pg 003</b>
<b>PRE-SETUP CHECK LIST</b>	<b>pg 007</b>
<b>INSTALLATION</b>	<b>pg 015</b>
<b>SET-UP INSTRUCTION IN WINTER</b>	<b>pg 015</b>
<b>USING THE SPA</b>	<b>pg 019</b>
<b>MAINTENANCE</b>	<b>pg 022</b>
<b>DISASSEMBLY AND STORAGE</b>	<b>pg 024</b>
<b>TROUBLESHOOTING</b>	<b>pg 026</b>
<b>ERROR CODES</b>	<b>pg 027</b>

---



**VISIT BESTWAY YOUTUBE CHANNEL**

FOR INSTRUCTION VIDEOS  
PLEASE VISIT:

**[BESTWAYCORP.COM/SUPPORT](http://BESTWAYCORP.COM/SUPPORT)**

# IMPORTANT SAFETY INSTRUCTIONS

## WARNING

# IMPORTANT SAFETY INSTRUCTIONS

When using this electrical equipment, basic safety precautions should always be followed, including the following:

## READ AND FOLLOW ALL INSTRUCTIONS.

**WARNING** – To reduce the risk of injury, do not permit children to use this product unless they are closely supervised at all times.

A wire connector is provided on this unit to connect a minimum 6 AWG (13.3 mm<sup>2</sup>) solid copper conductor between this unit and any metal equipment, metal enclosures of electrical equipment, metal water pipe, or conduit within 5 feet (1.5 m) of the unit.

**DANGER** – Risk of injury.

a) Replace damaged cord immediately.

b) Do not bury cord.

c) Connect to a grounded, grounding type receptacle only.

**WARNING** – This product is provided with a ground-fault circuit-interrupter integrated with the power plug at the end of the cord. The GFCI must be tested before each use. With the product operating, push the test button on the GFCI and the product should not operate. Push the reset button on the GFCI and the product should now operate normally. When the product fails to operate in this manner, there is a ground current flowing indicating the possibility of an electrical shock. Disconnect the power until the fault has been identified and corrected.

**DANGER** – Risk of Accidental Drowning. Extreme caution must be exercised to prevent unauthorized access by children. To avoid accidents, ensure that children cannot use this spa unless they are supervised at all times.

**DANGER** – Risk of Injury. The suction fittings in this spa are sized to match the specific water flow created by the pump. Should the need arise to replace the suction fittings or the pump, be sure that the flow rates are compatible. Never operate spa if the suction fittings are broken or missing. Never replace a suction fitting with one rated less than the flow rate marked on the original suction fitting.

**DANGER** – Risk of Electric Shock. Install at least 5 feet (1.5 m) from all metal surfaces. As an alternative, a spa may be installed within 5 feet of metal surfaces if each metal surface is permanently connected by a minimum 6 AWG (13.3 mm<sup>2</sup>) solid copper conductor to the wire connector on the terminal box that is provided for this purpose.

**DANGER** – Risk of Electric Shock. Do not permit any electric appliance, such as a light, telephone, radio, or television, within 5 feet (1.5 m) of a spa.

**WARNING** – To reduce the risk of injury:

a) The water in a spa should never exceed 104°F (40°C). Water temperatures between 100°F (38°C) and 104°F (40°C) are considered safe for a healthy adult. Lower water temperatures are recommended for young children and when spa use exceeds 10 minutes.

b) Since excessive water temperatures have a high potential for causing fetal damage during the early months of pregnancy, pregnant or possibly pregnant women should limit spa water temperatures to 100°F (38°C).

c) Before entering a spa, the user should measure the water temperature with an accurate thermometer since the tolerance of water temperature-regulating devices

varies.

- d) The use of alcohol, drugs, or medication before or during spa use may lead to unconsciousness with the possibility of drowning.
- e) Obese persons and persons with a history of heart disease, low or high blood pressure, circulatory system problems, or diabetes should consult a physician before using a spa.
- f) Persons using medication should consult a physician before using a spa since some medication may induce drowsiness while other medication may affect heart rate, blood pressure, and circulation.

**WARNING:** TO AVOID ELECTRIC SHOCK, DO NOT USE THE SPA WHEN IT IS RAINING.

**WARNING:** Water attracts children; Always attach a spa cover after each use.

**WARNING:** TO REDUCE THE RISK OF INJURY: Never add water that is higher than 104°F (40°C) into the Spa.

## CONSULT YOUR PHYSICIAN FOR RECOMMENDATIONS. CAUTION:

We strongly recommend not to unfold and inflate the spa if the ambient temperature is below 59°F(15°C). We suggest inflating the spa indoors, and then continuing set up outdoors. If the outdoor temperature is lower than 42.8°F(6°C), the spa heater must always be on. In this mode, the Freeze Shield™ system can keep the internal temperature between 42.8°F(6°C) and 50°F(10°C) to prevent damage, such as water freezing in the pipes or the circulation system.

**IMPORTANT:** If the Freeze Shield™ system isn't working, alarms will pop up on the spa. Be sure to check the status of your spa if the outdoor temperature is below 42.8°F(6°C). In case of a long-term absence from home when there is a risk of temperatures falling below 42.8°F(6°C), we strongly suggest disassembling the spa and storing it following the storage procedure.

**CAUTION:** Do not use the spa alone.

**CAUTION:** Always enter and exit the spa slowly and cautiously. Wet surfaces are slippery.

**CAUTION:** To avoid damage to the pump, the spa must never be operated unless the spa is filled with water.

**CAUTION:** Immediately leave spa if the user feels uncomfortable or sleepy.

**NOTE:** Please examine equipment before use. Notify Bestway® at the customer service address listed on this manual for any damaged or missing parts at the time of purchase. Verify that the equipment components represent the model that you had intended to purchase.

## SAVE THESE INSTRUCTIONS

**WARNING:** CHILDREN SHOULD NOT USE SPAS OR HOT TUBS WITHOUT ADULT SUPERVISION.

**WARNING:** DO NOT USE SPAS OR HOT TUBS UNLESS ALL SUCTION GUARDS ARE INSTALLED TO PREVENT BODY AND HAIR ENTRAPMENT.

**WARNING:** PEOPLE USING MEDICATIONS AND/OR HAVING AN ADVERSE MEDICAL HISTORY SHOULD CONSULT A PHYSICIAN BEFORE USING A SPA OR HOT TUB.

**WARNING:** PEOPLE WITH INFECTIOUS DISEASES SHOULD NOT USE A SPA OR HOT TUB.

**WARNING:** TO AVOID INJURY, EXERCISE CARE WHEN ENTERING OR EXITING THE SPA OR HOT TUB.

**WARNING:** DO NOT USE DRUGS OR ALCOHOL BEFORE OR DURING THE USE OF A SPA OR HOT TUB TO AVOID UNCONSCIOUSNESS AND POSSIBLE DROWNING.

**WARNING:** PREGNANT OR POSSIBLY PREGNANT WOMEN SHOULD CONSULT A PHYSICIAN BEFORE USING A SPA OR HOT TUB.

**WARNING:** WATER TEMPERATURE IN EXCESS OF 38°C (100°F) CAN BE INJURIOUS TO YOUR HEALTH.

**WARNING:** BEFORE ENTERING THE SPA OR HOT TUB, MEASURE THE WATER TEMPERATURE WITH AN ACCURATE THERMOMETER.

**WARNING:** DO NOT USE A SPA OR HOT TUB IMMEDIATELY FOLLOWING STRENUOUS EXERCISE.

**WARNING:** PROLONGED IMMERSION IN A SPA OR HOT TUB CAN BE INJURIOUS TO YOUR HEALTH.

**WARNING:** DO NOT PERMIT ELECTRIC APPLIANCES (SUCH AS A LIGHT, TELEPHONE, RADIO, OR TELEVISION) WITHIN 1.5 M OF THIS SPA OR HOT TUB.

**CAUTION:** MAINTAIN WATER CHEMISTRY IN ACCORDANCE WITH MANUFACTURER'S INSTRUCTIONS.

**ASSEMBLY: THE PROVIDED WARNING LABEL**



# WARNING

## REDUCE THE RISK OF ELECTROCUTION

1. NEVER PLACE AN ELECTRIC APPLIANCE WITHIN 5 FEET OF SPA.

## REDUCE THE RISK OF CHILD DROWNING

1. SUPERVISE CHILDREN AT ALL TIMES.
2. ATTACH SPA COVER AFTER EACH USE.

## REDUCE THE RISK OF OVERHEATING

1. CHECK WITH A DOCTOR BEFORE USE IF PREGNANT, DIABETIC, IN POOR HEALTH, OR UNDER MEDICAL CARE.
2. EXIT IMMEDIATELY IF UNCOMFORTABLE, DIZZY, OR SLEEPY. SPA HEAT CAN CAUSE HYPERTHERMIA AND UNCONSCIOUSNESS.
3. SPA HEAT IN CONJUNCTION WITH ALCOHOL, DRUGS, OR MEDICATION CAN CAUSE UNCONSCIOUSNESS.

## WHEN PREGNANT, SOAKING IN HOT WATER FOR LONG PERIODS CAN HARM YOUR FETUS. MEASURE WATER TEMPERATURE BEFORE ENTERING.

1. DO NOT ENTER SPA IF WATER IS HOTTER THAN 100°F(38°C)
2. DO NOT STAY IN SPA FOR LONGER THAN 10 MINUTES.

**NOTE:** The warning label must be posted near your spa in a readable position during using your spa.

1. Take out the warning label from the accessory kit.
2. Carefully peel the warning label.

3. Affix the warning label.

To order the warning label, please contact your local Bestway After Sales Service.

## SELECTED LOCATION

**IMPORTANT:** Due to the combined weight of the SaluSpa, water, and users, it is extremely important that the surface where the SaluSpa is installed is smooth, flat, level and capable of supporting the weight for the entire time the SaluSpa is installed (not on the carpet or other similar material). If the SaluSpa is placed on a surface which does not meet these requirements, any damage caused by improper support is not covered under the manufacturer's warranty. It is the responsibility of the SaluSpa owner to assure the integrity of the surface at all times.

### 1. Indoor Installation:

**Be aware of special requirements if you install the spa indoors.**

- Humidity is a natural side effect with SaluSpa installation. First determine the effects of moisture on exposed wood, paper, etc. in the proposed location. To minimize these effects, it is best to provide plenty of ventilation to the selected area. An architect can help determine if more ventilation is needed.

### 2. Outdoor Installation:

- During filling, draining or when in use, water may spill out of the spa. Therefore the SaluSpa should be installed near a floor drain.
- Do not leave the spa surface exposed to direct sunlight for long periods of time.

## GFCI WARNING

**IMPORTANT: RISK OF ELECTRIC SHOCK. THE GFCI MUST BE TESTED BEFORE TURNING ON THE PUMP EACH TIME.**

**WARNING:** The GFCI plug must be tested before each use to avoid risk of electric shock.

**WARNING:** Before inserting plug into a power outlet, make sure the current rate of the power outlet is suitable for the pump.

**WARNING:** Do not use the pump if this test fails. For assistance, please visit the support section on our website, [www.bestwaycorp.com](http://www.bestwaycorp.com).

**WARNING:** Using an extension lead or multi plug adaptor with the spa heater can cause the plug to overheat, causing damage to the equipment and surrounding items. The spa is a class I electrical appliance and must be connected directly to a grounded socket. It is recommended to only use a socket which is resistant to humidity and capable of high power loading. Regularly check the plug and socket for signs of damage before using the spa – do not use the spa if the plug or socket is damaged. If you are unsure about the quality of the electrical supply, please consult a qualified electrician before use.

# PRE-SETUP CHECK LIST

## PARTS CHECKS

Please examine equipment before use. Notify Bestway® customer service of any damaged or missing parts at the time of purchase. Verify that the equipment components represent the model that you had intended to purchase. For reference please use the diagrams below.

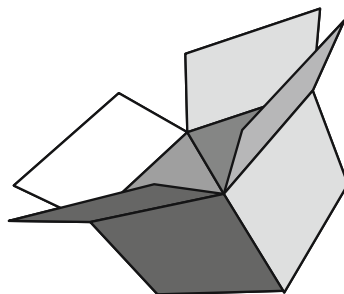

### MIAMI AIRJET S100104 (60002)

— 71" x 26" / 1.80 m x 66 cm



2 - 4



2-3°F/h  
1-1.5°C/h



320 gal/h  
1,211 L/h



0.034-0.055Bar  
0.5-0.8PSI

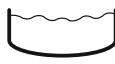

177 gal  
669 L



1,534 Lb  
696 kg

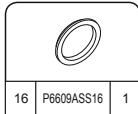
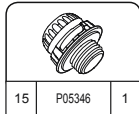
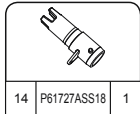
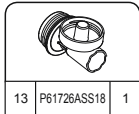
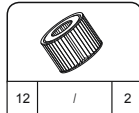
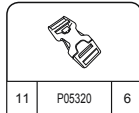
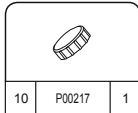
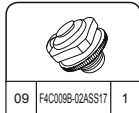
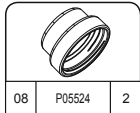
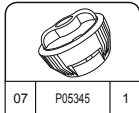
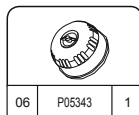
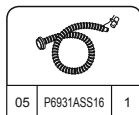
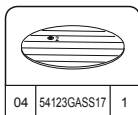
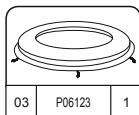
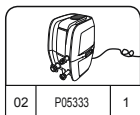
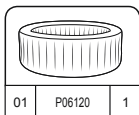

# CANCUN AIRJET S100104 (60004)

— 71" x 26" / 1.80 m x 66 cm



2 - 4



2-3°F/h  
1-1.5°C/h



320 gal/h  
1,211 L/h



0.034-0.055Bar  
0.5-0.8PSI



177 gal  
669 L



1,534 Lb  
696 kg

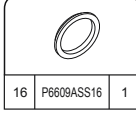
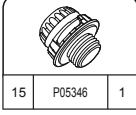
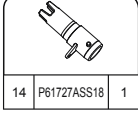
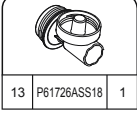
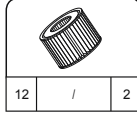
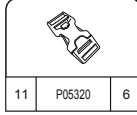
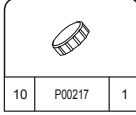
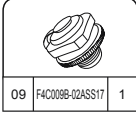
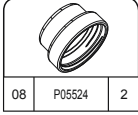
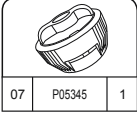
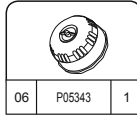
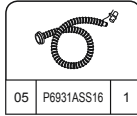
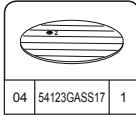
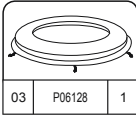
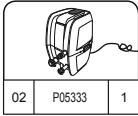
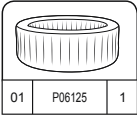

# BAHAMAS AIRJET S100104 (60006)

— 71" x 26" / 1.80 m x 66 cm



2 - 4



2-3°F/h  
1-1.5°C/h



320 gal/h  
1,211 L/h



0.034-0.055Bar  
0.5-0.8PSI



177 gal  
669 L



1,534 Lb  
696 kg

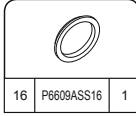
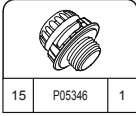
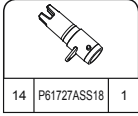
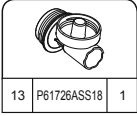
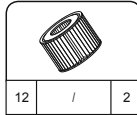
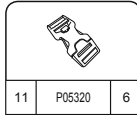
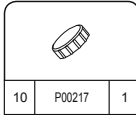
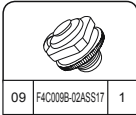
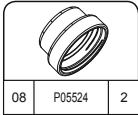
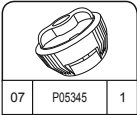
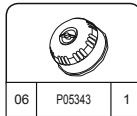
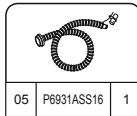
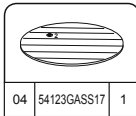
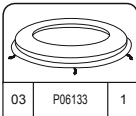
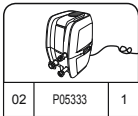
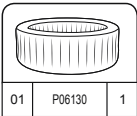



# TAHITI AIRJET S100104 (60008)

— 71" x 26" / 1.80 m x 66 cm



2 - 4



2-3°F/h  
1-1.5°C/h



320 gal/h  
1,211 L/h



0.034-0.055Bar  
0.5-0.8PSI



177 gal  
669 L



1,534 Lb  
696 kg

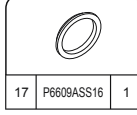
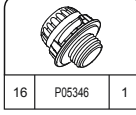
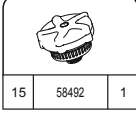
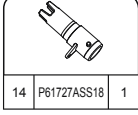
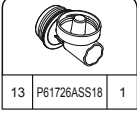
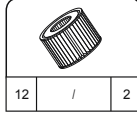
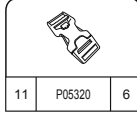
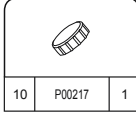
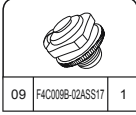
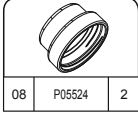
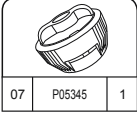
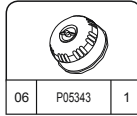
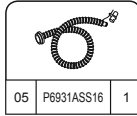
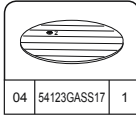
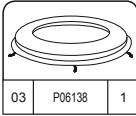
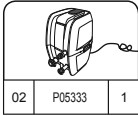
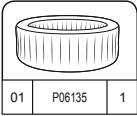

# BALI AIRJET S100104 (60010)

— 71" x 26" / 1.80 m x 66 cm



2 - 4



2-3°F/h  
1-1.5°C/h



320 gal/h  
1,211 L/h



0.034-0.055Bar  
0.5-0.8PSI



177 gal  
669 L



1,534 Lb  
696 kg

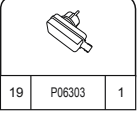
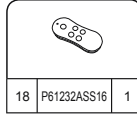
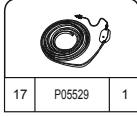
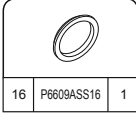
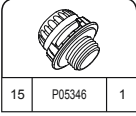
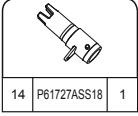
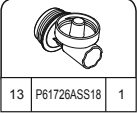
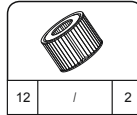
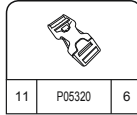
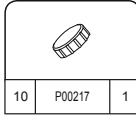
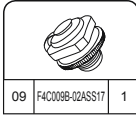
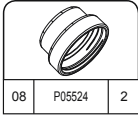
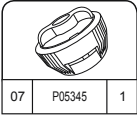
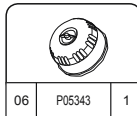
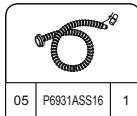
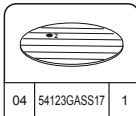
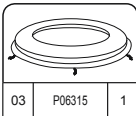
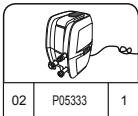
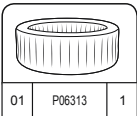

## IBIZA AIRJET S100104 (60016)

— 71" x 71" x 26" / 1.80 m x 1.80 m x 66 cm



4 - 6



2-3°F/h  
1-1.5°C/h



320 gal/h  
1,211 L/h



0.034-0.055Bar  
0.5-0.8PSI



205 gal  
778 L



1,779 Lb  
807 kg

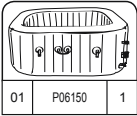

01 P06150 1

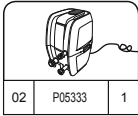

02 P05333 1

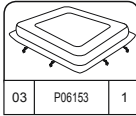

03 P06153 1

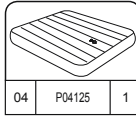

04 P04125 1

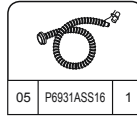

05 P6931ASS16 1

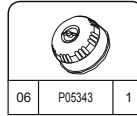

06 P05343 1

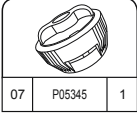

07 P05345 1

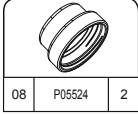

08 P05524 2

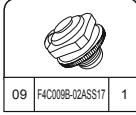

09 F4C009B-02ASS17 1

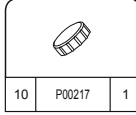

10 P00217 1

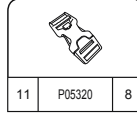

11 P05320 8

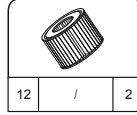

12 / 2

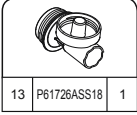

13 P61726ASS18 1

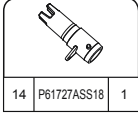

14 P61727ASS18 1

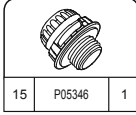

15 P05346 1

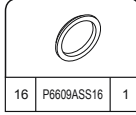

16 P6609ASS16 1

## PALM SPRINGS AIRJET S100104 (60018)

— 77" x 28" / 1.96 m x 71 cm



4 - 6



2-3°F/h  
1-1.5°C/h



320 gal/h  
1,211 L/h



0.08Bar  
1.2PSI



242 gal  
916 L



2,103 Lb  
954 kg

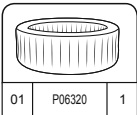

01 P06320 1

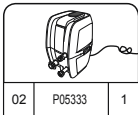

02 P05333 1

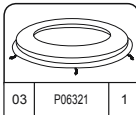

03 P06321 1

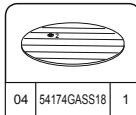

04 54174GASS18 1

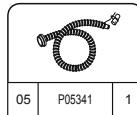

05 P05341 1

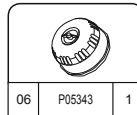

06 P05343 1

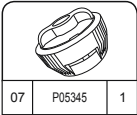

07 P05345 1

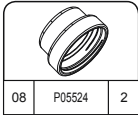

08 P05524 2

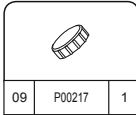

09 P00217 1

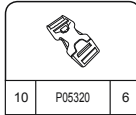

10 P05320 6

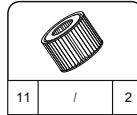

11 / 2

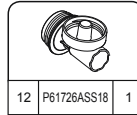

12 P61726ASS18 1

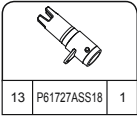

13 P61727ASS18 1

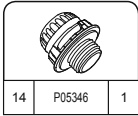

14 P05346 1

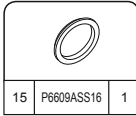

15 P6609ASS16 1

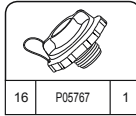







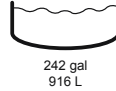

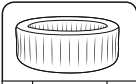
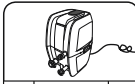
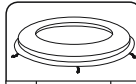

16 P05767 1

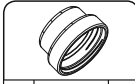
## HONOLULU AIRJET S100104 (60020)

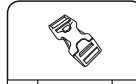
— 77" x 28" / 1.96 m x 71 cm

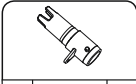
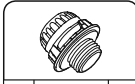

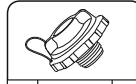



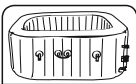
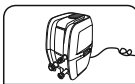
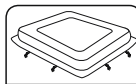
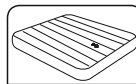
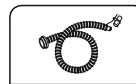

 01 P05191 1	 02 P05333 1	 03 P05195 1	 04 54174GASS18 1	 05 P05341 1	 06 P05343 1
 07 P05345 1	 08 P05524 2	 09 P00217 1	 10 P05320 6	 11 / 2	 12 P61726ASS18 1
 13 P61727ASS18 1	 14 P05346 1	 15 P6609ASS16 1	 16 P05767 1		

## HAWAII AIRJET S100104 (60022)

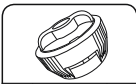
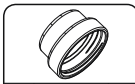
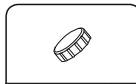
— 71" x 71" x 28" / 1.80 m x 1.80 m x 71 cm

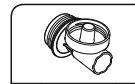
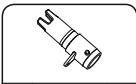
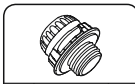

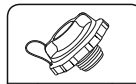
 01 P05185 1	 02 P05333 1	 03 P05189 1	 04 P04125 1	 05 P05341 1	 06 P05343 1
 07 P05345 1	 08 P05524 2	 09 P00217 1	 10 P05320 8	 11 / 2	 12 P61726ASS18 1
 13 P61727ASS18 1	 14 P05346 1	 15 P6609ASS16 1	 16 P05767 1		

# ST. MORITZ AIRJET S100104 (60024)

— 85" x 28" / 2.16 m x 71 cm



5 - 7



1-2°F/h  
0.5-1°C/h



320 gal/h  
1,211 L/h











0.08Bar  
1.2PSI

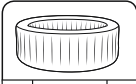

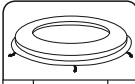
314 gal  
1190 L

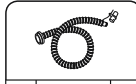

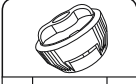
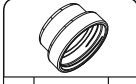
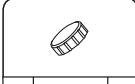
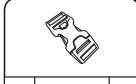
2,668 Lb  
1210 kg

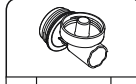
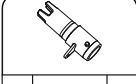
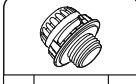
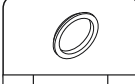
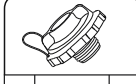
 01 P05197 1	 02 P05333 1	 03 P05201 1	 04 54175GASS18 1	 05 P05341 1	 06 P05343 1
 07 P05345 1	 08 P05524 2	 09 P00217 1	 10 P05320 8	 11 / 2	 12 P61726ASS18 1
 13 P61727ASS18 1	 14 P05346 1	 15 P6609ASS16 1	 16 P05767 1		

# HELSINKI AIRJET S100104 (60026)

— 71" x 26" / 1.80 m x 66 cm



5 - 7



1-2°F/h  
0.5-1°C/h



320 gal/h  
1,211 L/h











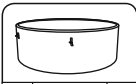
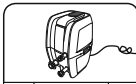
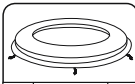

0.48-0.69Bar  
7-10PSI

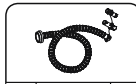

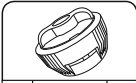
297 gal  
1123 L

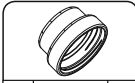
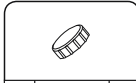
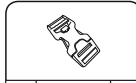

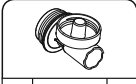
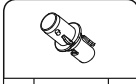
2,548 Lb  
1155 kg

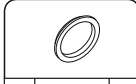
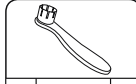
 01 P05203 1	 02 P05333 1	 03 P05207 1	 04 P04122 1	 05 P05482 1	 06 P05343 1
 07 P05345 1	 08 P06327 1	 09 P05524 2	 10 P00217 1	 11 P05320 6	 12 / 2
 13 P61726ASS18 1	 14 P05344 1	 15 P05346 1	 16 P6609ASS16 1	 17 / 1	

# ST.LUCIA AIRJET S100104 (60038)

— 67" x 26" / 1.70 m x 66 cm



2 - 3



2-3°F/h  
1-1.5°C/h



320 gal/h  
1,211 L/h



















0.034-0.055Bar  
0.5-0.8PSI



160 gal  
605 L



1,389 Lb  
630 kg

					
01 P06158 1	02 P05333 1	03 P06164 1	04 P05091 1	05 P6931ASS16 1	06 P05343 1
					
07 P05345 1	08 P05524 2	09 F4C009B-02ASS17 1	10 P00217 1	11 P05320 5	12 / 2
					
13 P61726ASS18 1	14 P61727ASS18 1	15 P05346 1	16 P6609ASS16 1		

# HOLLYWOOD AIRJET S100104 (60060)

— 77" x 26" / 1.96 m x 66 cm



4 - 6



2-3°F/h  
1-1.5°C/h



320 gal/h  
1,211 L/h















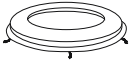







0.034-0.055Bar  
0.5-0.8PSI



240 gal  
908 L



2,066 Lb  
937 kg

					
01 P06199 1	02 P05333 1	03 P06202 1	04 54112GASS15 1	05 P6931ASS16 1	06 P05343 1
					
07 P05345 1	08 P05524 2	09 F4C009B-02ASS17 1	10 P00217 1	11 P05320 6	12 / 2
					
13 P61726ASS18 1	14 P61727ASS18 1	15 P05346 1	16 P6609ASS16 1	17 P05513 1	18 P61232ASS16 1
					
19 P06303 1	20 P06280 4				

# ARUBA AIRJET S100104 (60062)

— 67" x 26" / 1.70 m x 66 cm



2 - 3



2-3°F/h  
1-1.5°C/h



320 gal/h  
1,211 L/h













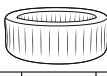

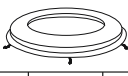

0.034-0.055Bar  
0.5-0.8PSI

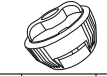
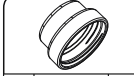
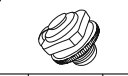

160 gal  
605 L



1,389 Lb  
630 kg

 01 P06161 1	 02 P05333 1	 03 P06166 1	 04 P05091 1	 05 P6931ASS16 1	 06 P05343 1
 07 P05345 1	 08 P05524 2	 09 F4C009B-02ASS17 1	 10 P00217 1	 11 P05320 5	 12 / 2
 13 P61726ASS18 1	 14 P61727ASS18 1	 15 P05346 1	 16 P6609ASS16 1		

# FIJI AIRJET S100104 (60086)

— 71" x 26" / 1.80 m x 66 cm



2 - 4



2-3°F/h  
1-1.5°C/h



320 gal/h  
1,211 L/h















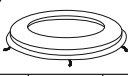
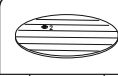

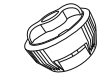
0.034-0.055Bar  
0.5-0.8PSI



177 gal  
669 L



1,534 Lb  
696 kg

 01 P06282 1	 02 P05333 1	 03 P06285 1	 04 54123GASS17 1	 05 P6931ASS16 1	 06 P05343 1
 07 P05345 1	 08 P05524 2	 09 F4C009B-02ASS17 1	 10 P00217 1	 11 P05320 6	 12 / 2
 13 P61726ASS18 1	 14 P61727ASS18 1	 15 P05346 1	 16 P6609ASS16 1		

# INSTALLATION



## SET-UP INSTRUCTION IN WINTER

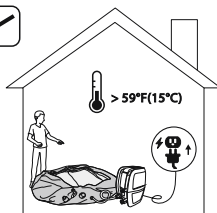
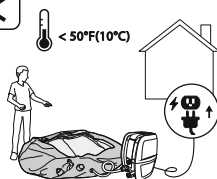

It is important to follow these suggestions if you are setting up the spa during the winter period. This will prevent damage to the PVC material and extend the life of your product drastically.

- If the ambient temperature is below 50°F (10°C), we suggest keeping the package indoor where the temperature is above 59°F (15°C) for at least 2h before inflation. This will make the spa liner more flexible and easier to set up.
- Open the package in the same room where the temperature is above 59°F (15°C), and inflate the spa using the spa heater.
- Position the spa liner outdoor in the desired position, connect the spa heater and fill with water.

**Important:** The water temperature used to fill the spa must be above 42.8°F (6°C), otherwise when you begin to operate with the spa heater, the E03 alarm will appear.

**Important:** If the Freeze Shield™ system isn't working, alarms will pop up on the spa. Be sure to check the status of your spa if the outdoor temperature is below 42.8°F (6°C). In case of a long-term absence from home when there is a risk of temperatures falling below 42.8°F (6°C), we strongly suggest disassembling the spa and storing it following the storage procedure. When you assemble the spa, the automatic warm function will turn on. In this condition, the spa can be used when the temperature is lower than 42.8°F (6°C).

**NOTE:** The air pressure gauge of the hand pump only shows the air pressure higher than 5 psi, which is normal. When the air pressure in the product is lower than 5 psi, the air pressure gauge will not show a value (Only for drop stitch spa).

1

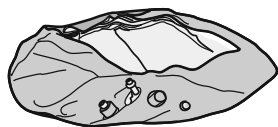

2



3

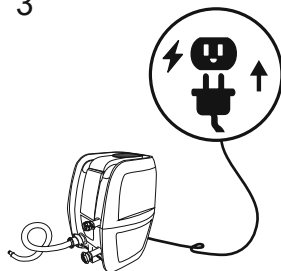

4

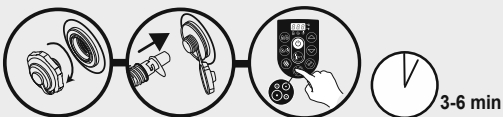
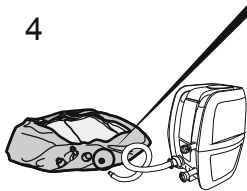

HELSINKI

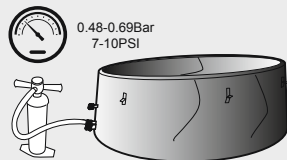

HOLLYWOOD BALI

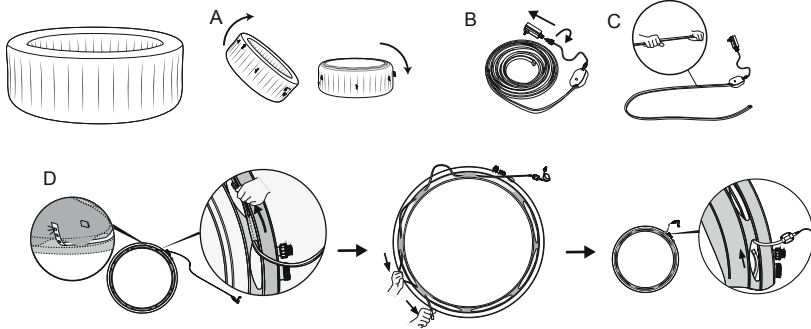

5

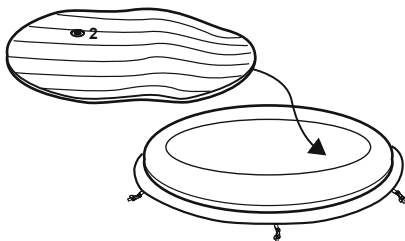

6

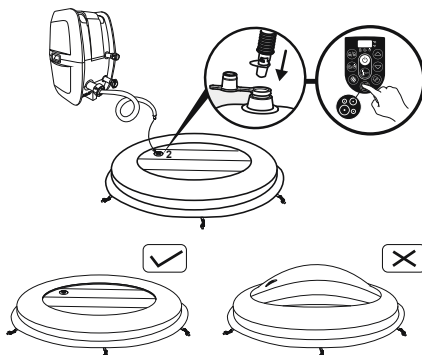



7

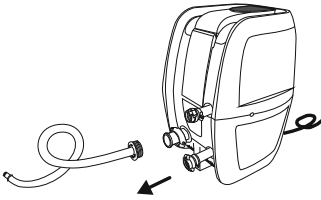

8

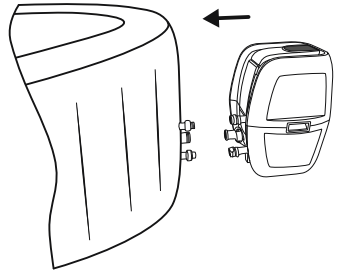

9

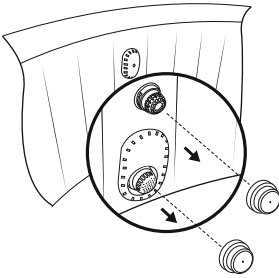

10

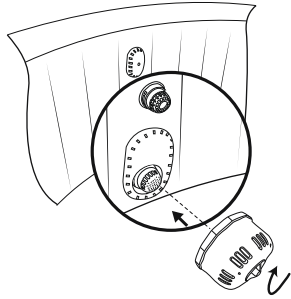

11.1



11.2 HOLLYWOOD

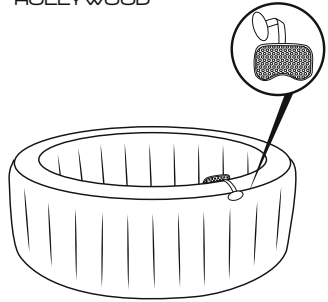

### GFCI TEST

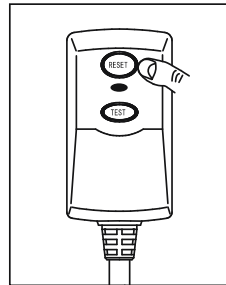
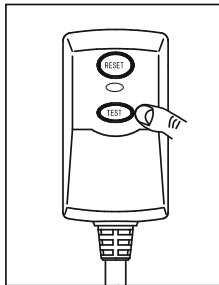
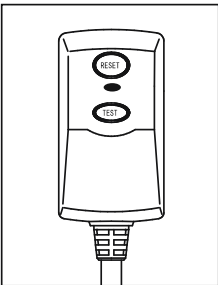

When inflating, you will notice that air will be expelled from the area where the air hose connects to the pump, this is normal for technique requirements.

**Important:** Don't cover the holes on the base of the inflation hose. This operation will over inflate the liner and damage the structure.

Do not use an air compressor to inflate the pool.

Do not drag the pool on rough ground as this may cause damage to the pool liner.

Inflation time for reference only.

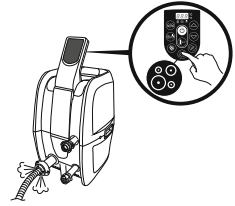

### **Air Valve Check (for spa with quick inflation/deflation valve)**

Always check the air valve carefully before inflation to ensure there is not an air leak. If the air valve is loose, use the provided wrench to fasten the air valve following these steps:

With one hand, hold the backside of the air valve from the inner side of the spa wall and turn the wrench clockwise.

### **NOTE:**

1. Do not over tighten.
2. Do not adjust the air valve connector when the spa is in use.

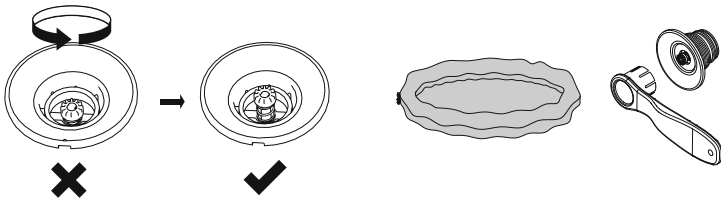

# USING THE SPA

Hyperthermia occurs when the internal temperature of the body reaches a level several degrees above the normal body temperature of 98.6°F(37°C). The symptoms of hyperthermia include an increase in the internal temperature of the body, dizziness, lethargy, drowsiness, and fainting. The effects of hyperthermia include failure to perceive heat, failure to recognize the need to exit spa or hot tub, unawareness of impending hazard, fetal damage in pregnant women, physical inability to exit the spa or hot tub, and unconsciousness resulting in the danger of drowning.

**WARNING** – The use of alcohol, drugs, or medication can greatly increase the risk of fatal hyperthermia.

**WARNING: WATER TEMPERATURE IN EXCESS OF 100°F(38°C) CAN BE INJURIOUS TO YOUR HEALTH.**

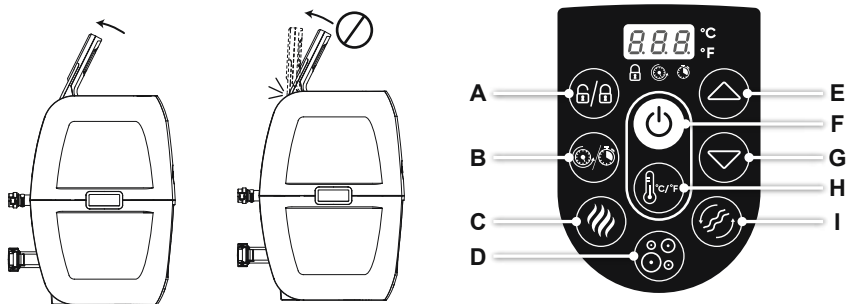

**A. LOCK/UNLOCK BUTTON:** The pump has a 5-minute auto-lock, this light will turn on. To lock or unlock the pump, place a finger over the lock/unlock button for 3 seconds.



**B. POWER-SAVING TIMER BUTTON:** Designed to help avoid wasting power by setting the time and duration of the heating cycle for the spa. This way, you can enjoy your spa at the time you desire, without needing to leave the heater on at all times.

#### STEP 1: Set the heating duration

1. Press the button until the LED starts to flash.
2. Press the or button to adjust the heating duration (From 1-999 hours).
3. Press the button again to confirm the heating duration.

#### STEP 2: Set the number of hours FROM NOW when the heater will activate

1. After setting the heating duration, the LED starts to flash.
2. Press the or button to adjust the hours until time of activation (From 0-999 hours).
3. Press button again or simply touch nothing for 10 seconds to confirm the setting. The LED will light steadily, and the countdown to heater activation will begin.

To modify the timer settings: Press the button and use the or button to adjust. Cancel the setting: Press the button for 2 seconds.

**NOTE:** After setting, the screen flashes the current temperature and time alternately.

**NOTE:** Timer adjustment (amount of time with the heater ON) may be set from 1 to 999 hours; Reservation time adjustment (the number of hours FROM NOW when the heater will begin to function) may be set from 0 to 999 hours. If the timer is set at 0 hour, the heating system will activate immediately.

Note that the timer is one time per use - the user sets the duration of the heating cycle, and how many hours from now the heating cycle begins. The timer does NOT repeat until reset.



**C. HEAT BUTTON:** Use this button to activate the heating system. When the light above the heat button is red, the heating system is activated. When the light is green, the water is at the set temperature and the heating system is at rest.

**NOTE:** If the heating system is activated the filtration system will automatically start.

**NOTE:** After turning off the heating system the filtration system will continue to operate.

**NOTE:** If the spa heater is on when the water temperature is below 42.8°F(6°C), the heating system will warm the water until 50°F(10°C) automatically.



**D. MASSAGE SYSTEM BUTTON:** Use this button to activate the massage system, which has a 30-minute auto-shutoff feature. The light above the Massage System Button displays red when activated.

**IMPORTANT:** Do not run the Massage system when the cover is attached. Air can accumulate inside the spa and cause irreparable damage to the cover and bodily harm.

**NOTE:** Heat and massage system work together to create a warm massage experience.



**E/G. TEMPERATURE ADJUSTMENT BUTTONS:** Pressing the Temperature Increase or Decrease buttons will cause the LED to flash. When it is flashing you can adjust to the desired temperature setting. If you hold these buttons down the values will rapidly increase or decrease. The new and desired temperature setting will remain on the LED display for 3 seconds to confirm the new value.



**NOTE:** The default temperature is 95°F(35°C).

**NOTE:** Temperature adjustment ranges from 68°F(20°C) to 104°F(40°C).



**F. ON/OFF BUTTON:** Press this button for 2 seconds to active the control panel buttons and the light turns to green. Press this button for 2 seconds to turn off all currently activated functions.



**H. CELSIUS/FAHRENHEIT TOGGLE:** The temperature can be displayed in either Fahrenheit or Celsius.



**I. WATER FILTER BUTTON:** This button turns the filter pump on and off. The light above the Water Filter Button displays red when activated.



**POWER-SAVING TIMER LED:**

This flashing LED means you are setting the heating duration. The light will be on when the heating function starts to work.



This flashing LED means you are setting the number of hours FROM NOW when the heater will activate. When the light is on, the Power-Saving Timer function is set.

**NOTE:** The WATER HEATER rate may change in the conditions below:

- When the outdoor temperature is below 59°F(15°C).
- If the cover is not in position when the heating function is activated.

**NOTE:** To display the current water temperature, run the filter system for at least a minute.

The water temperature as tested by an external thermometer may vary from the temperature as displayed on the spa panel by as much as approximately 35.6°F(2°C).

## WINTER USE INSTRUCTIONS



- You can keep the spa on during winter when the temperature is lower than 42.8°F(6°C). The Freeze Shield™ system automatically keeps the water temperature between 42.8°F(6°C) and 50°F(10°C), and it will prevent the water from freezing. **Important:** If the water temperature is below 42.8°F(6°C), the spa heater must always be on. In this mode, the Freeze Shield™ system can keep the internal temperature between 42.8°F(6°C) and 50°F(10°C) to prevent damage, such as water freezing in the pipes or the circulation system. **Important:** If the Freeze Shield™ system isn't working, alarms will pop up on the spa. Be sure to check the status of your spa if the outdoor temperature is below 42.8°F(6°C). In case of a long-term absence from home when there is a risk of temperatures falling below 42.8°F(6°C), we strongly suggest disassembling the spa and storing it following the storage procedure.
- Any damage as a result of using the spa in these conditions is the responsibility of the customer. Do not use the spa when the ambient temperature reaches 14°F(-10°C).

## IMPORTANT

To reach 104°F(40°C), the heating duration required is based on the starting water temperature and ambient temperature, the data below is purely for reference. To display the current water temperature, run the filter system for at least a minute.

Ambient Temperature	Water Temperature	Set Temperature	Heating Duration
50°F(10°C)	50°F(10°C)	104°F(40°C)	32 h
59°F(15°C)	59°F(15°C)	104°F(40°C)	26 h
68°F(20°C)	68°F(20°C)	104°F(40°C)	20 h
77°F(25°C)	77°F(25°C)	104°F(40°C)	14 h
86°F(30°C)	86°F(30°C)	104°F(40°C)	9 h

- Be sure to cover the spa with the spa cover whenever the heating function is activated. Leaving the spa uncovered will increase the heating duration required.
- When the spa is assembled with water, do not switch off the spa heater if the temperature is lower than 42.8°F(6°C).

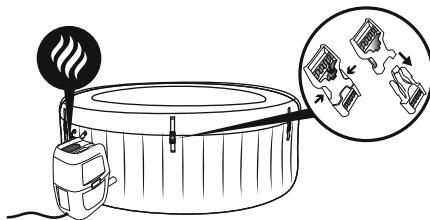

Power Rate	Massage Tube Blower	Heat Element	Water Pump
110-120V AC, 60Hz, Single Phase 12A at 20°C	6.5A	11.3A at 20°C	0.7A

# MAINTENANCE

**CAUTION:** You must ensure the pump is unplugged before beginning spa maintenance to avoid risk of injury or death.

**Adding Air:** Your spa will require additional air to be added from time to time. Changes in temperature from day to night will change the pressure in the spa and may cause a certain amount of deflation. Please follow the assembly instructions and inflate to the accurate pressure needed.

When you need to use the pump for inflation, please block the hoses to prevent water from escaping, then disconnect the pump, screw on the cap (P00217) to avoid water coming out from the air pipe.

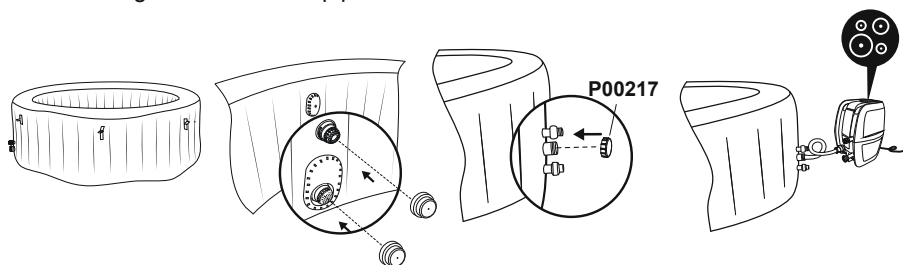

## Cover Maintenance

The cover shall be cleaned inside and out periodically using a suitable solution that includes adequate disinfection (e.g. 10 mg/l of Free Chlorine).

## Filter Cartridge Maintenance

To ensure your spa water stays clean, check and clean your filter cartridges every day follow the steps below.

**NOTE:** We recommend changing your filter cartridges every week or, if the filter cartridges remain soiled and discolored, they should be replaced.

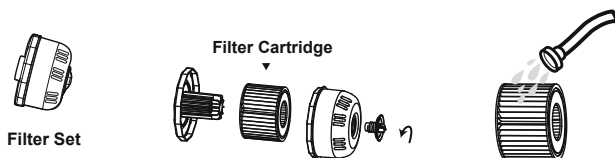

## Water Maintenance

Many pollutants in the water settle on surfaces below the water line. These pollutants can cause bacterial, algal or fungal growth. It is recommended that spas are cleaned as regularly as necessary. After a time, tenacious stains or biofilms may develop on the accessible surfaces below the water line or high concentrations of salts or unwanted reaction by-products may also occur. Depending on hygienic condition, cleanliness, visibility, odour, debris and stains, it is recommended to change the water completely and clean/disinfect the spa. When emptying the spa, the regulations and the instructions for draining the water shall be observed.

Keeping your spa water clean and chemically balanced is necessary. Simply cleaning the filter cartridge is not enough for proper maintenance, we recommend you use pool chemicals to maintain water chemistry and chlorine or bromine tablets (do not use granules) with the chemical dispenser.

Water quality will be directly related to frequency of use, number of users and overall maintenance of the spa. The water should be changed every 3 days if there is no chemical treatment being performed with the water. It is highly recommended to use tap water for spa filling to minimize the influence of unwanted content, such as minerals. Barefoot areas and relaxing areas shall be cleaned as well. No cleaning water may flow into the spa or spa water cycle. The dirt and cleaning agents shall be rinsed carefully to drain in the spa surround. **Note:** We recommend you take a shower before using your SaluSpa, as cosmetic products, lotions, and other residues on the skin can quickly degrade water quality. To use the chemical dispenser, please follow the below instruction.

**Using chemical tablets (not included):**

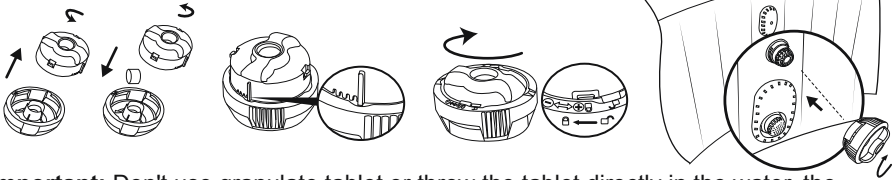

**Important:** Don't use granulate tablet or throw the tablet directly in the water, the chemical will deposit on the bottom and damage the material and discolored the PVC.

**Using chemical liquid (not included):**

**Important:** Add chemical liquid in small doses and in the center of the pool avoid direct contact of the chemical with the spa surface, the direct contact of chemical with spa material will damage the material and discolored the surface.

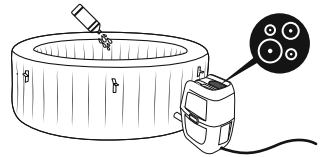

**NOTE:** Remove the chemical dispenser from spa when the spa is in use.

**IMPORTANT:** After performing chemical maintenance and before using the spa, use a test kit (not included) to test the water chemistry. We recommend maintaining your water as below table.

pH	Total Alkalinity	Free Chlorine
7.4-7.6	80-120ppm	2-4ppm

**NOTE:** Damage resulting from chemical imbalance is not covered by the warranty. Pool chemicals are potentially toxic and should be handled with care. There are serious health risks from chemical vapors and the incorrect labeling and storage of chemical containers. Please consult your local pool supply retailer for more information about chemical maintenance. Pay close attention to the chemical manufacturer's instructions. spa damage resulting from misuse of chemicals and mismanagement of spa water is not covered by the warranty.

**Important:** Over usage of chemical will discolored the printing and all points of the spa material, in worse case damage the structure of the spa liner.

# DISASSEMBLY AND STORAGE

## DRAINING THE SPA

1.

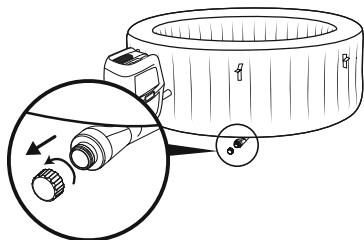

2.

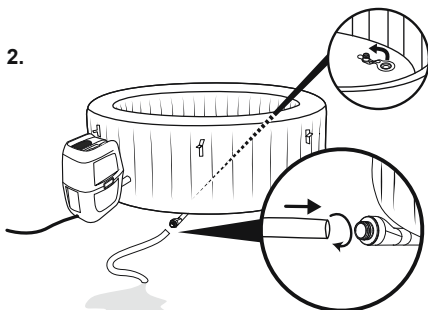

3. **NOTE:** Dry the spa pool.



4.

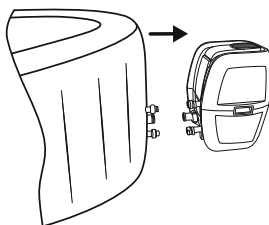

5.

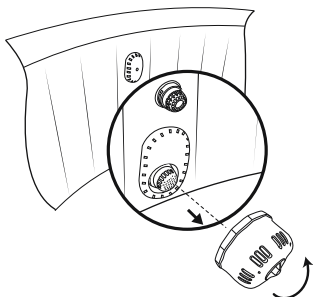

6.

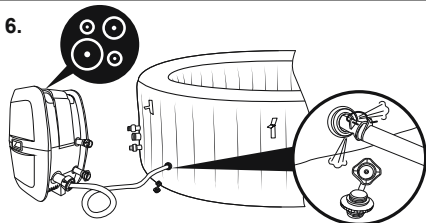

For Bali and Hollywood Spas:  
You may find steam inside the air chamber, and mold may appear after storage if there is water inside. Please unscrew the valve and use the pipe to blow into the air chamber until you dry all the steam inside. This operation may take 2-5 hours.

## Only for Drop stitch Spa

1.



2.

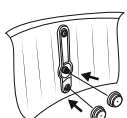

3.

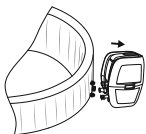

4.

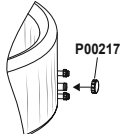

5.

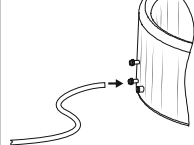

6.

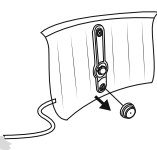

7.

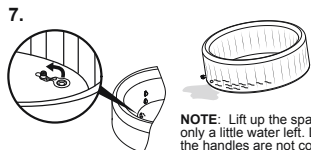

**NOTE:** Lift up the spa when there is only a little water left. Damages to the handles are not covered under the warranty.

8. **NOTE:** Dry the spa pool

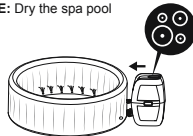



Make sure the spa and pump are completely dry. This is essential to extend the life of the spa. We recommend using the pump to blow dry the spa, pump and pipes. Remove the filter sets and discard the used filter cartridges. Re-attach the two stopper caps onto the spa's inlet and outlet valves. It is recommended you store the spa in its original package in a warm [above 59°F(15°C)] and dry place.

## CLEANING THE SPA

Detergent residues and dissolved solids from bathing suits and chemicals may build up on the spa walls. Use soap and water to clean the walls and rinse thoroughly.

NOTE: DO NOT use hard brushes or abrasive cleaners.

## DEFLATION

Your spa is equipped with a deflation function to remove all the air from inside the chamber to make it easier to pack and store.

Screw valve 

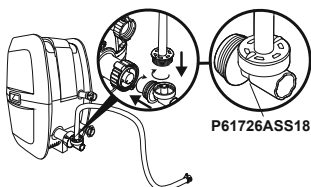

P61727ASS18

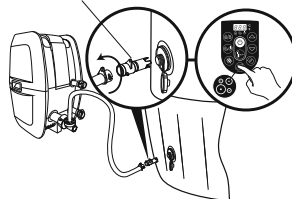

Quick inflation/deflation valve 

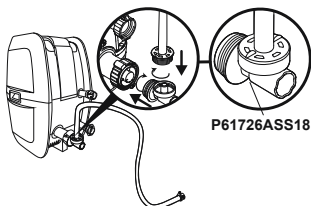

P05344

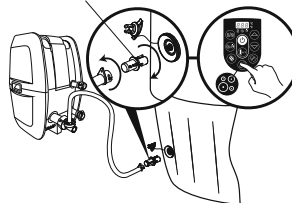

## REPAIR

### For PVC part.

If the spa is torn or punctured, use the provided underwater adhesive repair patch.

1. Clean area to be repaired.
2. Carefully peel patch.
3. Press patch over area to be repaired.
4. Wait 30 seconds before inflation.



### For Tritech PVC material.

If the spa is torn or punctured, use the provided PVC repair patch and glue (not included) following these steps:







1. Clean and dry area to be repaired.
2. Cut the provided PVC patch to appropriate size.
3. Use glue (not included) to coat the one side of the newly cut patch. Make sure the glue is evenly distributed.
4. Wait for 30 seconds and then place the cut patch with glue over the damaged area.
5. Smooth out any bubbles of air that may be trapped underneath, and press firmly for two minutes.
6. The product is once again ready for use. Repeat this process should further leaks occur.
7. Wait 30 minutes before inflation.

# TROUBLESHOOTING

Bestway strives to provide the most trouble-free spas on the market. If you experience any problems whatsoever, do not hesitate to contact Bestway or your authorized dealer. Here are some helpful tips to help you to diagnose and rectify some common sources of trouble.

Problems	Probable Causes	Solutions
Pump does not operate	<ul style="list-style-type: none"> <li>- Power failure</li> <li>- GFCI broken</li> </ul>	<ul style="list-style-type: none"> <li>- Check power source</li> <li>- For assistance, please visit the support section on our website, <a href="http://www.bestwaycorp.com">www.bestwaycorp.com</a>.</li> </ul>
Pump does not heat properly	<ul style="list-style-type: none"> <li>- Temperature set too low</li> <li>- Dirty Filter Cartridge</li> <li>- The thermal cut-out cut off</li> <li>- Spa is not covered</li> <li>- Heating element failed</li> </ul>	<ul style="list-style-type: none"> <li>- Set to a higher temperature refer to section pump operation</li> <li>- Clean/replace the filter cartridge refer to section filter cartridge cleaning and replacement</li> <li>- Unplug the pump, and put the plug in a dry, cool place. Only restart the pump when the water temperature reaches 95°F(35°C) or lower</li> <li>- Attach the cover.</li> <li>- For assistance, please visit the support section on our website, <a href="http://www.bestwaycorp.com">www.bestwaycorp.com</a>.</li> </ul>
Massage System does not work	<ul style="list-style-type: none"> <li>- Air Pump is overheating</li> <li>- The massage system stops automatically</li> <li>- Air pump is broken</li> </ul>	<ul style="list-style-type: none"> <li>- Unplug the pump and wait two hours until the pump has cooled. Insert the plug and press the massage system button</li> <li>- Press the massage system button to reactivate</li> <li>- For assistance, please visit the support section on our website, <a href="http://www.bestwaycorp.com">www.bestwaycorp.com</a>.</li> </ul>
Pump adapters are not level with the spa adapters	<ul style="list-style-type: none"> <li>- One characteristic of PVC is that it changes shape, which is normal</li> </ul>	<ul style="list-style-type: none"> <li>- Elevate the pump with wood or another type of insulated material to bring the pump's adapters level with the spa's adapters</li> </ul>
Spa pool leakage	<ul style="list-style-type: none"> <li>- Spa is torn or punctured</li> <li>- Air valve is loose</li> </ul>	<ul style="list-style-type: none"> <li>- Use provided repair patch</li> <li>- Using soapy water, cover the air-valve to check if air is leaking, if so, use the provided wrench to fasten the air-valve following these steps:               <ol style="list-style-type: none"> <li>1. Deflate the spa.</li> <li>2. With one hand, hold the backside of the air valve from the inner side of the spa wall and turn the wrench clockwise.</li> </ol> </li> </ul>
Water is not clean	<ul style="list-style-type: none"> <li>- Insufficient filtering time</li> <li>- Dirty Filter Cartridge</li> <li>- Improper water maintenance</li> </ul>	<ul style="list-style-type: none"> <li>- Increase filtration time</li> <li>- Clean/replace the Filter Cartridge (refer to Filter Cartridge Cleaning and Replacement section)</li> <li>- Refer to the chemical manufacturer's instructions</li> </ul>
Control panel not working	<p>The control panel has an auto-lock, which is activated after 5 minutes of inactivity. The LED display has one icon: . If the lock icon is highlighted, the control panel is locked.</p> <ul style="list-style-type: none"> <li>- Control panel is not activated.</li> </ul>	<ul style="list-style-type: none"> <li>- To unlock the control panel, press the  button for 3 seconds. If the control panel will not unlock, restart the pump – unplug and plug in the pump.</li> <li>- Press the on/off button for 2 seconds. If the problem persists, for assistance, please visit the support section on our website, <a href="http://www.bestwaycorp.com">www.bestwaycorp.com</a>.</li> </ul>
GFCI test failed	<p>There is a defect in your spa</p>	<p>For assistance, please visit the support section on our website, <a href="http://www.bestwaycorp.com">www.bestwaycorp.com</a>.</p>
What kind of chemicals should be used for water maintenance?	<p>Please consult your local chemical supplier for information about chemical maintenance. Pay close attention to the chemical manufacturer's instructions.</p>	
Water leaks from the adapters between the pump and spa	<ul style="list-style-type: none"> <li>- Seals are missing inside the pump adapters</li> <li>- Seals are not in correct position</li> <li>- Seals are damaged</li> <li>- Adapters are not tightened correctly</li> </ul>	<ul style="list-style-type: none"> <li>- Insert the stopper caps on the spa ports to prevent the water from escaping and disconnect the pump. Check if the seals are in place.</li> <li>- If the seals are not in the correct position, open the gears, and place the seals in correct position.</li> <li>- If the seals are damaged, they must be replaced. For assistance, please visit the support section on our website, <a href="http://www.bestwaycorp.com">www.bestwaycorp.com</a>.</li> <li>- If the seals are in correct position, the adapters are not tightened correctly. Connect the pump to the spa, hand-tighten the adapters, and remove the stopper caps from the spa ports. If there is leakage, tighten the adapter until there is no leakage.</li> </ul>

# ERROR CODES

CAUSES	REASONS	SOLUTIONS
<p>The water flow sensors work without pressing the filter or heat button.</p> 	<ol style="list-style-type: none"> <li>The water flow sensor flags didn't fall back into the correct position.</li> <li>The water flow sensors are broken.</li> </ol>	<ol style="list-style-type: none"> <li>Unplug the plug, strike the side of the pump but not violently, and plug it back in.</li> <li>For assistance, please visit the support section on our website, <a href="http://www.bestwaycorp.com">www.bestwaycorp.com</a>.</li> </ol>
<p>After starting or during the functions of filtering or/and heating, the water flow sensors do not detect water flow.</p> 	<ol style="list-style-type: none"> <li>You forgot to remove the 2 stopper caps from inside the pool.</li> <li>Filter cartridges are dirty.</li> <li>Activate the filter or heat system and put your hand in front of the outlet pipe inside the pool to check if you can feel water flowing out.             <ol style="list-style-type: none"> <li>If no water flows out the water pump is broken.</li> </ol> </li> <li>Water flows out but the alarm  appears, then the water flow sensors are broken.</li> <li>Filter blockage</li> <li>Bent pipes or poor water flow through the plastic pipes of the liner</li> <li>Debris screens are blocked: debris screens can become blocked by hard water due to calcium build-up.</li> <li>Perished washers The washers within the spa couplings may have become perished or worn.</li> </ol>	<ol style="list-style-type: none"> <li>Remove the 2 stopper caps before heating, refer to Assembly section in the User's Manual.</li> <li>Remove the filter set from inside the pool and push the filter or heat button. If no alarm appears, clean or change the filter cartridges install the filter set inside the pool.</li> <li>For assistance, please visit the support section on our website, <a href="http://www.bestwaycorp.com">www.bestwaycorp.com</a>.</li> <li>Clean the filter and check for damage. Replace or re-install as necessary. For assistance, please visit the support section on our website, <a href="http://www.bestwaycorp.com">www.bestwaycorp.com</a>.</li> <li>Please check through the spa connection to see if the pipes are bending. For assistance, please visit the support section on our website, <a href="http://www.bestwaycorp.com">www.bestwaycorp.com</a>.</li> <li>Empty the spa and place a garden hose inside the pipes to wash the debris. To be sure all debris is removed, perform the operation from the outside and inside of the spa. Use a toothbrush to remove any stubborn debris. For assistance, please visit the support section on our website, <a href="http://www.bestwaycorp.com">www.bestwaycorp.com</a>.</li> <li>Check the washers inside the coupling for damage. Unscrew the couplings and remove the washer for further inspection. For assistance, please visit the support section on our website, <a href="http://www.bestwaycorp.com">www.bestwaycorp.com</a>.</li> </ol>
<p>The pump's thermometer reads the water temperature below 40°F(4°C).</p> 	<ol style="list-style-type: none"> <li>The water temperature is lower than 40°F(4°C).</li> <li>If the water temperature is higher than 44.6°F(7°C), the pump's thermometer is broken.</li> </ol>	<ol style="list-style-type: none"> <li>The spa is not designed to operate with water temperatures lower than 40°F(4°C). Unplug the pump and only re-start the pump when the water temperature reaches 43°F(6°C).</li> <li>For assistance, please visit the support section on our website, <a href="http://www.bestwaycorp.com">www.bestwaycorp.com</a>.</li> </ol>
<p>The pump's thermometer reads the water temperature over 119°F(48°C).</p> 	<ol style="list-style-type: none"> <li>The water temperature is over 119°F(48°C).</li> <li>The ambient temperature is higher than 104°F(40°C) or the spa is exposed to direct sunlight for an extended period of time.</li> <li>If the water temperature is lower than 113°F(45°C), the pump's thermometer is broken.</li> </ol>	<ol style="list-style-type: none"> <li>The spa is not designed to operate with water temperatures greater than 104°F(40°C). Unplug the pump and only re-start the pump when the water temperature reaches 100°F(38°C) or lower.</li> <li>Disconnect the plug, detach the pump and drain the spa. After 15 minutes, reattach the pump, reconnect the plug and restart the heating function. If the alarm appears again, consider moving the spa to another location without direct sunlight.</li> <li>For assistance, please visit the support section on our website, <a href="http://www.bestwaycorp.com">www.bestwaycorp.com</a>.</li> </ol>
<p>The pump's thermometer connections have issues.</p> 	<ol style="list-style-type: none"> <li>The pump's thermometer connectors don't work properly.</li> <li>The pump's thermometer is broken.</li> </ol>	<p>For assistance, please visit the support section on our website, <a href="http://www.bestwaycorp.com">www.bestwaycorp.com</a>.</p>
<p>The thermal cut-out cut off.</p> 	<ol style="list-style-type: none"> <li>The ambient temperature is over 122°F(50°C) or the pump is directly under the sunshine.</li> <li>The thermal cut-out is broken.</li> </ol>	<ol style="list-style-type: none"> <li>Unplug the pump, and put the pump in a dry, cool place. Only re-start the pump when the water temperature reaches 93.2°F(34°C) or lower.</li> <li>For assistance, please visit the support section on our website, <a href="http://www.bestwaycorp.com">www.bestwaycorp.com</a>.</li> </ol>



# SALUSPA®

**Bestway**

# TABLE DES MATIÈRES

---

CONSIGNES DE SÉCURITÉ IMPORTANTES	pg 031
LISTE DE CONTRÔLE AVANT L'INSTALLATION	pg 035
INSTALLATION	pg 043
INSTRUCTIONS D'INSTALLATION EN HIVER	pg 043
UTILISATION DU SPA	pg 047
ENTRETIEN	pg 050
DÉMONTAGE ET RANGEMENT	pg 052
DÉPANNAGE	pg 054
CODES D'ERREUR	pg 055

---



**VISITEZ LA CHAÎNE YOUTUBE DE  
BESTWAY**

POUR LES VIDÉOS D'INSTRUCTIONS  
VEUILLEZ VISITER  
**BESTWAYCORP.COM/SUPPORT**

# CONSIGNES DE SÉCURITÉ IMPORTANTES

## ATTENTION D'IMPORTANTES CONSIGNES DE SÉCURITÉ

Lors de l'utilisation de cet équipement électrique, vous devez toujours suivre les consignes de sécurité de base, y compris les précautions suivantes.

## RESPECTEZ ET CONSERVEZ CES INSTRUCTIONS.

**AVERTISSEMENT** – Pour réduire les risques de blessure, ne permettez pas aux enfants d'utiliser ce produit à moins d'être étroitement surveillé tout le temps.

Un connecteur de fils est fourni avec ce dispositif pour raccorder un conducteur en cuivre massif de 6 AWG (13,3 mm<sup>2</sup>) minimum entre ce dispositif et tout équipement métallique, les boîtiers métalliques de l'équipement électrique, les conduits d'eau en métal ou les conduits à moins de 5 pieds (1,5 m) du dispositif.

**DANGER** – Risque de blessure.

- Remplacez immédiatement le cordon endommagé.
- N'enterrez pas le cordon.
- Ne branchez que sur une prise de terre.

**ATTENTION** - Ce produit est fourni avec un disjoncteur de fuite de terre (GFCI) intégré avec la fiche d'alimentation à l'extrémité du cordon. Il faut tester le GFCI avant chaque utilisation. Quand le produit est en marche, appuyez sur la touche de test du GFCI et le produit devrait cesser de fonctionner. Appuyez sur la touche de réinitialisation sur le GFCI et le produit devrait recommencer à fonctionner normalement. Quand le produit ne fonctionne pas de cette manière, cela veut dire qu'un courant à la masse circule et donc qu'il existe un risque d'électrocution. Mettez hors tension jusqu'à ce que vous ayez identifié et corrigé la panne.

**DANGER** – Danger de Noyade. Ne pas laisser d'enfants s'approcher sans autorisation.

Pour éviter les accidents, assurez-vous que les enfants ne puissent jamais utiliser le spa sans surveillance.

**DANGER** – Risque de Blessure. Les raccords d'aspiration de ce spa sont dimensionnés pour répondre au débit d'eau spécifique créé par la pompe. Si vous avez besoin de changer les raccords d'aspiration ou la pompe, vérifiez que les débits soient compatibles. Ne faites jamais fonctionner la spa si les raccords d'aspiration sont brisés ou manquants. Ne jamais remplacer un raccord d'aspiration par un autre dont le débit nominal est inférieur à celui qui est indiqué sur le raccord d'aspiration original.

**DANGER** – Danger D'Électrocution. Installez-le à au moins 5 pieds (1,5 m) de toutes les surfaces métalliques. En alternative, il est possible d'installer un spa à moins de 5 pieds des surfaces métalliques si chacune d'entre elles est raccordée de manière permanente par un conducteur en cuivre massif de 6 AWG (13,3 mm<sup>2</sup>) minimum à un connecteur de fils sur un bornier prévu pour cela.

**DANGER** – Danger D'Électrocution. Ne laissez aucun appareil électrique, comme une lampe, un téléphone, une radio ou une télévision, à moins de 5 pieds (1,5 m) d'un spa.

**ATTENTION** – Pour réduire les risques de blessure:

- l'eau d'un spa ne doit jamais dépasser les 40°C. Les températures de l'eau comprises entre 100°F (38°C) et 40°C sont considérées comme étant sûres pour un adulte en bonne santé.  
Une température moindre est recommandée pour les jeunes enfants et lorsque le spa est utilisé pendant plus de dix minutes.
- Étant donné qu'une température excessive de l'eau risque d'être dangereuse durant les premiers mois de grossesse, les femmes enceintes ou en quête de grossesse doivent limiter la température de l'eau à 100°F (38°C).
- Avant d'entrer dans le spa, l'utilisateur doit mesurer la température de l'eau avec un thermomètre

- précis étant donné que la tolérance des appareils de réglage de la température de l'eau varie.
- d) La consommation d'alcool, de drogue ou de médicament avant ou en pendant l'utilisation d'un Spa peut faire perdre connaissance et engendre donc un risque de noyade.
  - e) Les personnes obèses et avec des antécédents cardiaques, des problèmes de tension artérielle, de circulation du sang ou de diabète doivent consulter un médecin avant d'utiliser le Spa.
  - f) Les personnes sous traitement doivent consulter un médecin avant d'utiliser un spa car certains médicaments peuvent engendrer un risque de noyade ou encore avoir des effets sur le rythme cardiaque, la pression artérielle et la circulation du sang.

**ATTENTION : POUR ÉVITER LES RISQUES D'ÉLECTROCUTION, NE PAS UTILISER LE SPA EN CAS DE PLUIE.**

**ATTENTION :** L'eau attire les enfants; Toujours recouvrir le spa de sa protection après chaque usage.

**ATTENTION – POUR RÉDUIRE LES RISQUES DE BLESSURE:** N'ajoutez jamais d'eau ayant une température supérieure à 104°F (40°C) dans le spa.

## **CONSULTEZ VOTRE MÉDECIN POUR D'ÉVENTUELLES RECOMMANDATIONS. ATTENTION :**

il est fortement recommandé de ne pas déplier et gonfler le spa si la température ambiante est inférieure à 59°F (15°C). Nous suggérons de gonfler le spa à l'intérieur, puis de continuer l'installation à l'extérieur. Si la température extérieure est inférieure à 42,8°F (6°C), le chauffage du spa doit toujours rester allumé. De cette manière, le système Freeze Shield™ peut maintenir la température à l'intérieur du spa entre 42,8°F (6°C) et 50°F (10°C) pour éviter les dégâts, comme par exemple l'eau gelant dans les tuyaux du système de circulation.

**IMPORTANT :** si le système Freeze Shield™ ne fonctionne pas, les alarmes se déclencheront dans le spa. Veuillez à bien vérifier l'état de votre spa si la température extérieure est inférieure à 42,8°F (6°C). En cas d'absence prolongée de votre domicile, lorsqu'il existe un risque de baisse de la température en dessous de 42,8°F (6°C), nous conseillons vivement de démonter le spa et de le ranger en suivant la procédure de rangement.

**ATTENTION :** Ne pas utiliser le Spa seul.

**ATTENTION :** Toujours entrer et sortir du spa lentement et en faisant attention. Les surfaces humides glissent.

**ATTENTION :** Pour éviter d'endommager la pompe, le spa ne doit jamais fonctionner sans eau.

**ATTENTION :** Sortir immédiatement du Spa en cas de malaise ou d'endormissement.

**REMARQUE:** Bien examiner l'équipement avant usage. Informez Bestway à l'adresse du service clientèle répertoriée dans ce manuel en cas de dommage ou pièces manquantes au moment de l'achat. Vérifiez que les composants de cet équipement correspondent bien au modèle que vous avez voulu acheter.

## **CONSERVEZ CES INSTRUCTIONS**

**ATTENTION : NE PAS LAISSER LES ENFANTS UTILISER UNE CUVE DE RELAXATION SANS SURVEILLANCE.**

**ATTENTION :** POUR ÉVITER QUE LES CHEVEUX OU UNE PARTIE DU CORPS PUISSENT ÊTRE ASPIRÉS, NE PAS UTILISER UNE CUVE DE RELAXATION SI LES GRILLES DE PRISE D'ASPIRATION NE SONT PAS TOUTES EN PLACE.

**ATTENTION :** LES PERSONNES QUI PRENNENT DES MÉDICAMENTS ET (OU) ONT DES PROBLÈMES DE SANTÉ DEVRAIENT CONSULTER UN MÉDECIN AVANT D'UTILISER UNE CUVE DE RELAXATION.

**ATTENTION :** LES PERSONNES ATTEINTES DE MALADIES INFECTIEUSES NE DEVRAIENT PAS UTILISER UNE CUVE DE RELAXATION.

**ATTENTION :** POUR ÉVITER DES BLESSURES, USER DE PRUDENCE EN ENTRANT DANS UNE CUVE DE RELAXATION ET EN SORTANT.

**ATTENTION :** POUR ÉVITER L'ÉVANOUISSEMENT ET LA NOYADE ÉVENTUELLE, NE PRENDRE NI DROGUE NI ALCOOL AVANT D'UTILISER UNE



CUVE DE RELAXATION NI QUAND ON S'Y TROUVE.

**ATTENTION** : LES FEMMES ENCEINTES, QUE LEUR GROSSESSE SOIT CONFIRMÉE OU NON, DEVRAIENT CONSULTER UN MÉDECIN AVANT D'UTILISER UNE CUVE DE RELAXATION.

**ATTENTION** : IL PEUT ÊTRE DANGEREUX POUR LA SANTÉ DE SE PLONGER DANS DE L'EAU À PLUS DE 38°C.

**ATTENTION** : AVANT D'UTILISER UNE CUVE DE RELAXATION, MESURER LA TEMPÉRATURE DE L'EAU À L'AIDE D'UN THERMOMÈTRE PRÉCIS.

**ATTENTION** : NE PAS UTILISER UNE CUVE DE RELAXATION IMMÉDIATEMENT APRÈS UN EXERCICE FATIGANT.

**ATTENTION** : L'UTILISATION PROLONGÉE D'UNE CUVE DE RELAXATION PEUT ÊTRE DANGEREUSE POUR LA SANTÉ.

**ATTENTION** : NE PAS PLACER D'APPAREIL ÉLECTRIQUE (LUMINAIRE, TÉLÉPHONE, RADIO, TÉLÉVISEUR, ETC) À MOINS DE 1.5 M DE CETTE CUVE DE RELAXATION.

**ATTENTION** : LA TENEUR DE L'EAU EN MATIÈRES DISSOUTES DOIT ÊTRE CONFORME AUX DIRECTIVES DU FABRICANT.

**MONTAGE: L'ÉTIQUETTE DE MISE EN GARDE FOURNIE**



# ATTENTION

## RÉDUISEZ LE RISQUE D'ÉLECTROCUTION

1. NE PLACEZ JAMAIS UN APPAREIL ELECTRIQUE A MOINS DE 1,52 M (5 PIEDS) DU SPA.

## RÉDUISEZ LE RISQUE DE NOYADE CHEZ LES ENFANTS

1. SUPERVISEZ TOUJOURS LES ENFANTS.

2. FIXEZ LA COUVERTURE DU SPA APRES CHAQUE UTILISATION.

## RÉDUISEZ LE RISQUE DE SURCHAUFFE

1. CONSULTEZ UN MEDECIN AVANT DE L'UTILISER SI VOUS ETES ENCEINTE, DIABETIQUE, SI VOUS AVEZ UNE SANTE FRAGILE OU QUE VOUS SUIVEZ UN TRAITEMENT MEDICAL.

2. SORTEZ IMMEDIATEMENT SI VOUS VOUS SENTEZ MAL, SI VOUS ETES PRIS DE VERTIGE OU SI VOUS AVEZ ENVIE DE DORMIR. LA CHALEUR DU SPA PEUT PROVOQUER UNE HYPERTHERMIE ET UNE PERTE DE CONNAISSANCE.

3. LA CHALEUR DU SPA ASSOCIEE A L'ALCOOL, DES DROGUES OU DES MEDICAMENTS PEUT ENTRAINER LA PERTE DE CONNAISSANCE.

**SI VOUS ÊTES ENCEINTE**, L'IMMERSION DANS DE L'EAU CHAUDE PENDANT DE LONGUES PERIODES PEUT NUIRE AU FŒTUS. MESUREZ LA TEMPERATURE DE L'EAU AVANT D'Y ENTRER.

1. N'ENTREZ PAS DANS LE SPA SI L'EAU SE TROUVE A UNE TEMPERATURE SUPERIEURE A 100°F (38°C)

2. NE RESTEZ PAS DANS LE SPA PENDANT PLUS DE 10 MINUTES.

**AVERTISSEMENT: L'étiquette de mise en garde doit être placée à proximité de votre spa dans une position vous permettant de la lire quand vous utilisez le spa.**

1. Sortez l'étiquette de mise en garde du kit des accessoires.

2. Décollez soigneusement l'étiquette de mise en garde.

3. Apposez l'étiquette de mise en garde.

Pour commander l'étiquette de mise en garde, veuillez vous adresser au service après-vente Bestway le plus proche.

## EMPLACEMENT CHOISI

**IMPORTANT:** À cause de l'accumulation du poids du SaluSpa, de l'eau et des utilisateurs, il est extrêmement important que la base sur laquelle est installé le bassin soit lisse, plate, à niveau et en mesure de supporter de manière uniforme ce poids tout le temps où le SaluSpa reste installé (pas sur un tapis ou une autre matière similaire). Si le SaluSpa est positionné sur une surface ne répondant pas à ces critères, tout dommage provoqué ne sera couvert par la garantie du fabricant. C'est le propriétaire du Spa qui est responsable de s'assurer l'intégrité du site à tout moment.

### 1. Installation à l'intérieur:

**Respectez les critères spécifiques suivants si vous installez le Spa à l'intérieur.**

- Le SaluSpa produit naturellement de l'humidité. Déterminez les effets de la moisissure de l'air sur le bois, le papier, etc. du lieu préposé. Pour minimiser ces effets, prévoir un maximum de ventilation dans la zone choisie. Un architecte peut vous aider à définir si plus de ventilation est nécessaire.

### 2. Installation à l'extérieur:

- En le remplissant, le vidant ou l'utilisant, l'eau risque de sortir du Spa. Le SaluSpa devra donc être installé près d'un siphon au sol.
- Ne laissez pas la surface du Spa exposée directement aux rayons du soleil pendant trop longtemps.

## ATTENTION GFCI

**IMPORTANT: RISQUE D'ÉLECTROCUTION. IL FAUT TESTER LE DISJONCTEUR DE FUITE DE TERRE À CHAQUE FOIS AVANT D'ALLUMER LA POMPE.**

**ATTENTION :** le bouchon GFCI doit être testé avant chaque utilisation pour éviter tout risque d'électrocution.

**ATTENTION :** avant de brancher la fiche dans la prise de courant, vérifiez que l'intensité du courant dans la prise soit adaptée à la pompe.

**ATTENTION :** n'utilisez pas la pompe si ce test s'est soldé par un échec. Si vous avez besoin d'aide, veuillez visiter la section assistance de notre site web, [www.bestwaycorp.com](http://www.bestwaycorp.com).

**ATTENTION :** l'utilisation d'une rallonge électrique ou d'un adaptateur multiprise avec le chauffage de spa peut entraîner une surchauffe de la fiche, ce qui pourrait endommager l'équipement et les éléments situés à proximité. Le spa est un appareil électrique de classe I et il faut le brancher directement sur une prise mise à la terre. Il est recommandé d'utiliser uniquement une prise pouvant résister à l'humidité et capable de supporter une charge de courant élevée. Avant d'utiliser le spa, examinez régulièrement la fiche et la prise pour déceler tout signe de détérioration – n'utilisez pas le spa si la fiche ou la prise est endommagée. Si vous n'êtes pas certain de la qualité de l'alimentation électrique, veuillez consulter un électricien qualifié avant de l'utiliser.

# LISTE DE CONTRÔLE AVANT L'INSTALLATION

## CONTRÔLE DES PIÈCES

Veillez examiner l'équipement avant de l'utiliser.

Informez le service après-vente de Bestway® si des pièces sont abîmées ou manquantes au moment de l'achat.

Vérifiez que les composants de l'équipement correspondent au modèle que vous souhaitez acheter. Pour les références, veuillez utiliser les schémas ci-dessous.

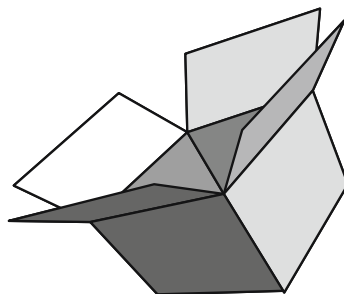

### MIAMI AIRJET S100104 (60002)

— 71" x 26" / 1.80 m x 66 cm



2 - 4



2-3°F/h  
1-1.5°C/h



320 gal/h  
1,211 L/h



0.034-0.055Bar  
0.5-0.8PSI



177 gal  
669 L



1,534 Lb  
696 kg

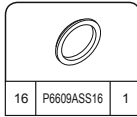
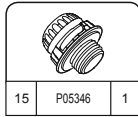
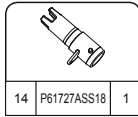
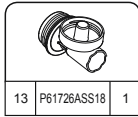
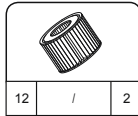
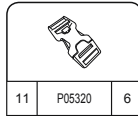
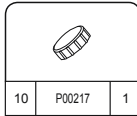
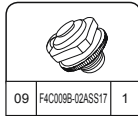
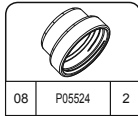
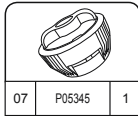
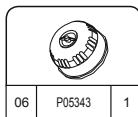
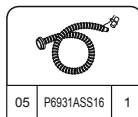
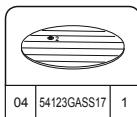
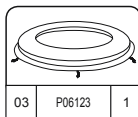
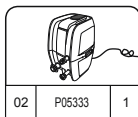
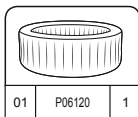

# CANCUN AIRJET S100104 (60004)

— 71" x 26" / 1.80 m x 66 cm



2 - 4



2-3°F/h  
1-1.5°C/h



320 gal/h  
1,211 L/h















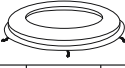
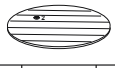

0.034-0.055Bar  
0.5-0.8PSI



177 gal  
669 L



1,534 Lb  
696 kg

					
01 P06125 1	02 P05333 1	03 P06128 1	04 54123GASS17 1	05 P6931ASS16 1	06 P05343 1
					
07 P05345 1	08 P05524 2	09 F4C009B-02ASS17 1	10 P00217 1	11 P05320 6	12 / 2
					
13 P61726ASS18 1	14 P61727ASS18 1	15 P05346 1	16 P6609ASS16 1		

# BAHAMAS AIRJET S100104 (60006)

— 71" x 26" / 1.80 m x 66 cm



2 - 4



2-3°F/h  
1-1.5°C/h



320 gal/h  
1,211 L/h















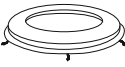



0.034-0.055Bar  
0.5-0.8PSI



177 gal  
669 L



1,534 Lb  
696 kg

					
01 P06130 1	02 P05333 1	03 P06133 1	04 54123GASS17 1	05 P6931ASS16 1	06 P05343 1
					
07 P05345 1	08 P05524 2	09 F4C009B-02ASS17 1	10 P00217 1	11 P05320 6	12 / 2
					
13 P61726ASS18 1	14 P61727ASS18 1	15 P05346 1	16 P6609ASS16 1		

# TAHITI AIRJET S100104 (60008)

— 71" x 26" / 1.80 m x 66 cm



2 - 4



2-3°F/h  
1-1.5°C/h



320 gal/h  
1,211 L/h



0.034-0.055Bar  
0.5-0.8PSI



177 gal  
669 L



1,534 Lb  
696 kg

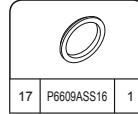
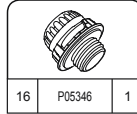
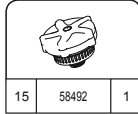
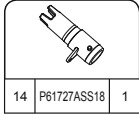
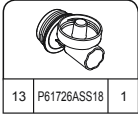
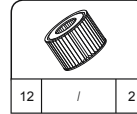
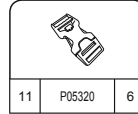
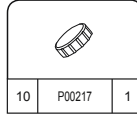
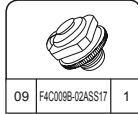
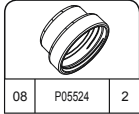
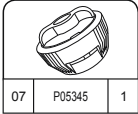
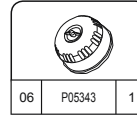
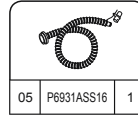
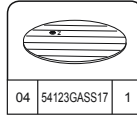
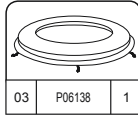
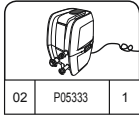
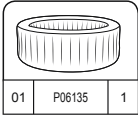

# BALI AIRJET S100104 (60010)

— 71" x 26" / 1.80 m x 66 cm



2 - 4



2-3°F/h  
1-1.5°C/h



320 gal/h  
1,211 L/h



0.034-0.055Bar  
0.5-0.8PSI



177 gal  
669 L



1,534 Lb  
696 kg

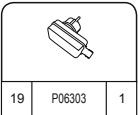
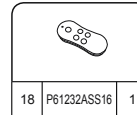
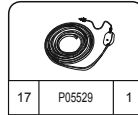
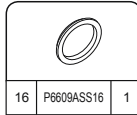
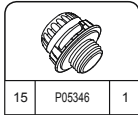
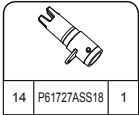
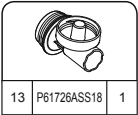
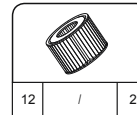
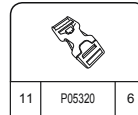
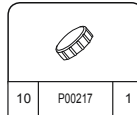
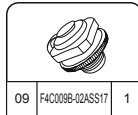
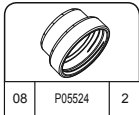
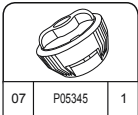
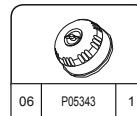
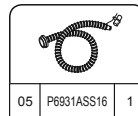
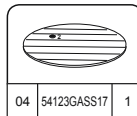
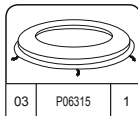
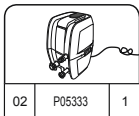
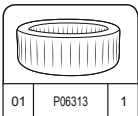

## IBIZA AIRJET S100104 (60016)

— 71" x 71" x 26" / 1.80 m x 1.80 m x 66 cm



4 - 6



2-3°F/h  
1-1.5°C/h



320 gal/h  
1,211 L/h



0.034-0.055Bar  
0.5-0.8PSI



205 gal  
778 L



1,779 Lb  
807 kg

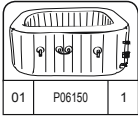

01 P06150 1

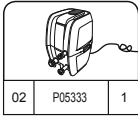

02 P05333 1

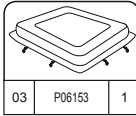

03 P06153 1

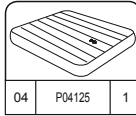

04 P04125 1

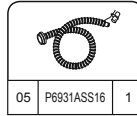

05 P6931ASS16 1

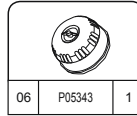

06 P05343 1

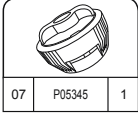

07 P05345 1

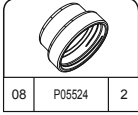

08 P05524 2

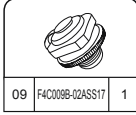

09 F4C009B-02ASS17 1

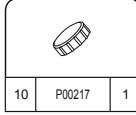

10 P00217 1

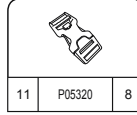

11 P05320 8

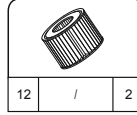

12 / 2

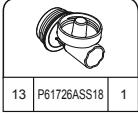

13 P61726ASS18 1

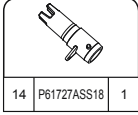

14 P61727ASS18 1

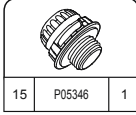

15 P05346 1

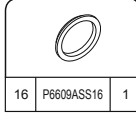

16 P6609ASS16 1

## PALM SPRINGS AIRJET S100104 (60018)

— 77" x 28" / 1.96 m x 71 cm



4 - 6



2-3°F/h  
1-1.5°C/h



320 gal/h  
1,211 L/h



0.08Bar  
1.2PSI



242 gal  
916 L



2,103 Lb  
954 kg

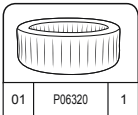

01 P06320 1

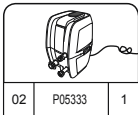

02 P05333 1

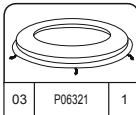

03 P06321 1

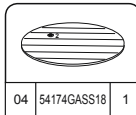

04 54174GASS18 1

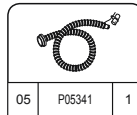

05 P05341 1

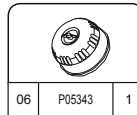

06 P05343 1

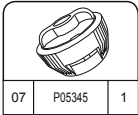

07 P05345 1

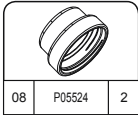

08 P05524 2

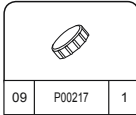

09 P00217 1

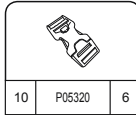

10 P05320 6

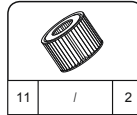

11 / 2

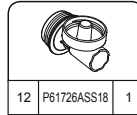

12 P61726ASS18 1

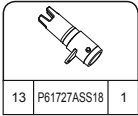

13 P61727ASS18 1

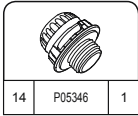

14 P05346 1

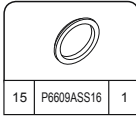

15 P6609ASS16 1

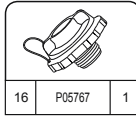









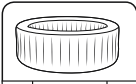
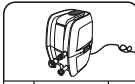
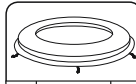

16 P05767 1

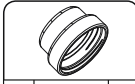
## HONOLULU AIRJET S100104 (60020)

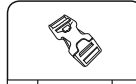
— 77" x 28" / 1.96 m x 71 cm

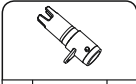
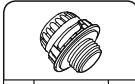

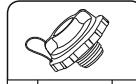



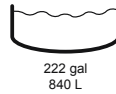

 01 P05191 1	 02 P05333 1	 03 P05195 1	 04 54174GASS18 1	 05 P05341 1	 06 P05343 1
 07 P05345 1	 08 P05524 2	 09 P00217 1	 10 P05320 6	 11 / 2	 12 P61726ASS18 1
 13 P61727ASS18 1	 14 P05346 1	 15 P6609ASS16 1	 16 P05767 1		

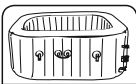
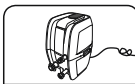
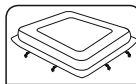
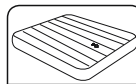
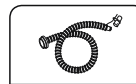
## HAWAII AIRJET S100104 (60022)

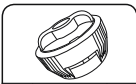
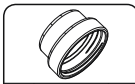
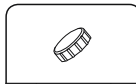
— 71" x 71" x 28" / 1.80 m x 1.80 m x 71 cm

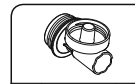
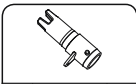
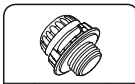

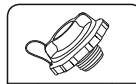
 01 P05185 1	 02 P05333 1	 03 P05189 1	 04 P04125 1	 05 P05341 1	 06 P05343 1
 07 P05345 1	 08 P05524 2	 09 P00217 1	 10 P05320 8	 11 / 2	 12 P61726ASS18 1
 13 P61727ASS18 1	 14 P05346 1	 15 P6609ASS16 1	 16 P05767 1		

## ST. MORITZ AIRJET S100104 (60024)

— 85" x 28" / 2.16 m x 71 cm



5 - 7



1-2°F/h  
0.5-1°C/h



320 gal/h  
1,211 L/h











0.08Bar  
1.2PSI

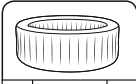

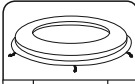
314 gal  
1190 L

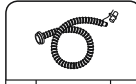

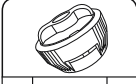
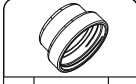
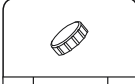
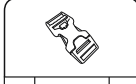
2,668 Lb  
1210 kg

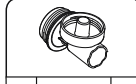
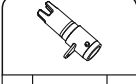
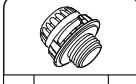
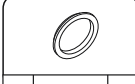
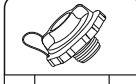
					
01 P05197 1	02 P05333 1	03 P05201 1	04 54175GASS18 1	05 P05341 1	06 P05343 1
					
07 P05345 1	08 P05524 2	09 P00217 1	10 P05320 8	11 / 2	12 P61726ASS18 1
					
13 P61727ASS18 1	14 P05346 1	15 P6609ASS16 1	16 P05767 1		

## HELSINKI AIRJET S100104 (60026)

— 71" x 26" / 1.80 m x 66 cm



5 - 7



1-2°F/h  
0.5-1°C/h



320 gal/h  
1,211 L/h











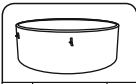
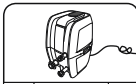
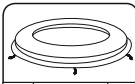

0.48-0.69Bar  
7-10PSI

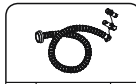

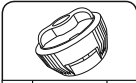
297 gal  
1123 L

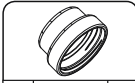
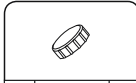
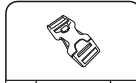

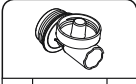
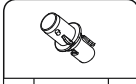
2,548 Lb  
1155 kg

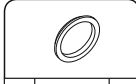
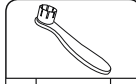
					
01 P05203 1	02 P05333 1	03 P05207 1	04 P04122 1	05 P05482 1	06 P05343 1
					
07 P05345 1	08 P06327 1	09 P05524 2	10 P00217 1	11 P05320 6	12 / 2
					
13 P61726ASS18 1	14 P05344 1	15 P05346 1	16 P6609ASS16 1	17 / 1	



## ST.LUCIA AIRJET S100104 (60038)

— 67" x 26" / 1.70 m x 66 cm



2 - 3



2-3°F/h  
1-1.5°C/h



320 gal/h  
1,211 L/h











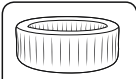

0.034-0.055Bar  
0.5-0.8PSI

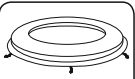
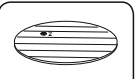

160 gal  
605 L

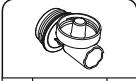
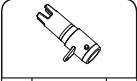
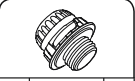
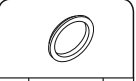

1,389 Lb  
630 kg

					
01 P06158 1	02 P05333 1	03 P06164 1	04 P05091 1	05 P6931ASS16 1	06 P05343 1
					
07 P05345 1	08 P05524 2	09 F4C009B-02ASS17 1	10 P00217 1	11 P05320 5	12 / 2
					
13 P61726ASS18 1	14 P61727ASS18 1	15 P05346 1	16 P6609ASS16 1		

## HOLLYWOOD AIRJET S100104 (60060)

— 77" x 26" / 1.96 m x 66 cm



4 - 6



2-3°F/h  
1-1.5°C/h



320 gal/h  
1,211 L/h













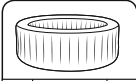

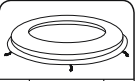
0.034-0.055Bar  
0.5-0.8PSI

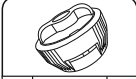

240 gal  
908 L

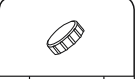

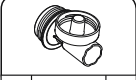
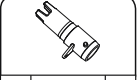
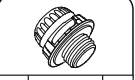
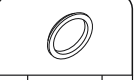
2,066 Lb  
937 kg

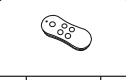
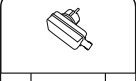
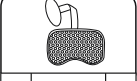
					
01 P06199 1	02 P05333 1	03 P06202 1	04 54112GASS15 1	05 P6931ASS16 1	06 P05343 1
					
07 P05345 1	08 P05524 2	09 F4C009B-02ASS17 1	10 P00217 1	11 P05320 6	12 / 2
					
13 P61726ASS18 1	14 P61727ASS18 1	15 P05346 1	16 P6609ASS16 1	17 P05513 1	18 P61232ASS16 1
					
19 P06303 1	20 P06280 4				

# ARUBA AIRJET S100104 (60062)

— 67" x 26" / 1.70 m x 66 cm



2 - 3



2-3°F/h  
1-1.5°C/h



320 gal/h  
1,211 L/h











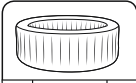

0.034-0.055Bar  
0.5-0.8PSI

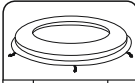

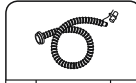
160 gal  
605 L

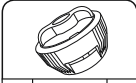
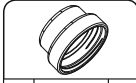
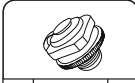
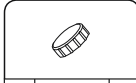

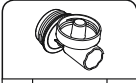
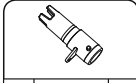
1,389 Lb  
630 kg

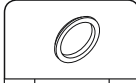
 01 P06161 1	 02 P05333 1	 03 P06166 1	 04 P05091 1	 05 P6931ASS16 1	 06 P05343 1
 07 P05345 1	 08 P05524 2	 09 F4C009B-02ASS17 1	 10 P00217 1	 11 P05320 5	 12 / 2
 13 P61726ASS18 1	 14 P61727ASS18 1	 15 P05346 1	 16 P6609ASS16 1		

# FIJI AIRJET S100104 (60086)

— 71" x 26" / 1.80 m x 66 cm



2 - 4



2-3°F/h  
1-1.5°C/h



320 gal/h  
1,211 L/h







0.034-0.055Bar  
0.5-0.8PSI



177 gal  
669 L

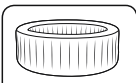
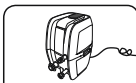
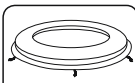
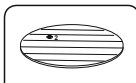
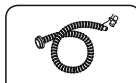

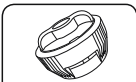
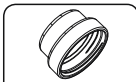
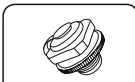
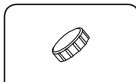
1,534 Lb  
696 kg

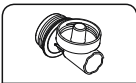
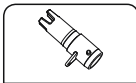
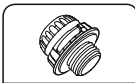
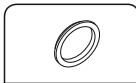
 01 P06282 1	 02 P05333 1	 03 P06285 1	 04 54123GASS17 1	 05 P6931ASS16 1	 06 P05343 1
 07 P05345 1	 08 P05524 2	 09 F4C009B-02ASS17 1	 10 P00217 1	 11 P05320 6	 12 / 2
 13 P61726ASS18 1	 14 P61727ASS18 1	 15 P05346 1	 16 P6609ASS16 1		

# INSTALLATION



## INSTRUCTIONS D'INSTALLATION EN HIVER

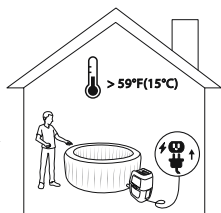
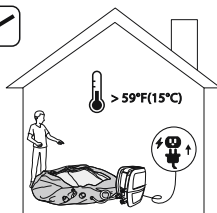
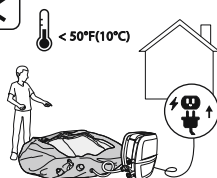

Il est important de suivre ces suggestions si vous installez le spa pendant l'hiver. Cela vous évitera d'endommager le PVC et prolongera considérablement la durée de vie de votre produit.

- Si la température ambiante est inférieure à 50 °F (10 °C), nous suggérons de conserver le colis à l'intérieur où la température est supérieure à 59 °F (15 °C) pendant au moins 2h avant de le gonfler. Cela rendra le liner du spa plus flexible et plus facile à installer.
- Ouvrez le colis dans la même pièce où la température est supérieure à 59 °F (15 °C), puis gonflez le spa au moyen du chauffage du spa.
- Positionnez le liner du spa à l'extérieur dans la position souhaitée, raccordez le chauffage du spa et remplissez le spa d'eau.

**Important :** la température de l'eau utilisée pour remplir le spa doit être supérieure à 42,8 °F (6 °C), sinon lorsque vous commencerez à le faire fonctionner avec le chauffage du spa, l'alarme E03 s'affichera.

**Important :** si le système Freeze Shield™ ne fonctionne pas, les alarmes se déclencheront dans le spa. Veillez à bien vérifier l'état de votre spa si la température extérieure est inférieure à 42,8 °F (6 °C). En cas d'absence prolongée de votre domicile, lorsqu'il existe un risque de baisse de la température en dessous de 42,8 °F (6 °C), nous conseillons vivement de démonter le spa et de le ranger en suivant la procédure de rangement. Lorsque vous montez le spa, la fonction chaleur automatique s'allumera. Dans cette condition, le spa peut être utilisé lorsque la température est inférieure à 42,8 °F (6 °C).

**REMARQUE :** le manomètre de la pompe à main ne montre que la pression de l'air supérieure à 5 psi, ce qui est normal. Lorsque la pression de l'air dans le produit est inférieure à 5 psi, le manomètre n'indique aucune valeur (uniquement pour le spa en Drop Stitch™).

1

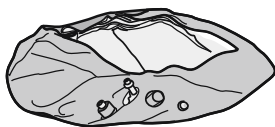

2

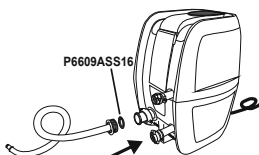

3

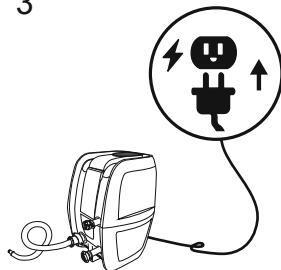

4

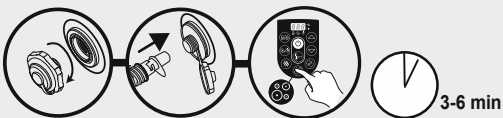
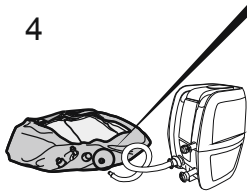

3-6 min

HELSINKI

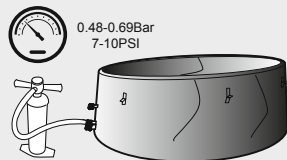
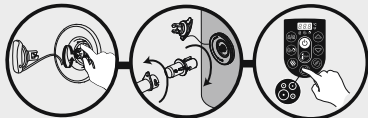

0.48-0.69Bar  
7-10PSI

HOLLYWOOD BALI

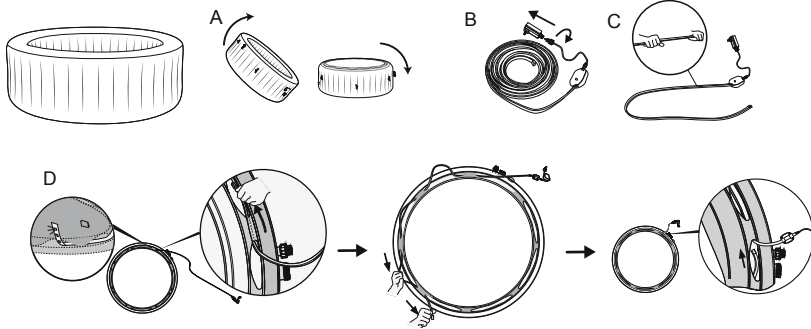

5

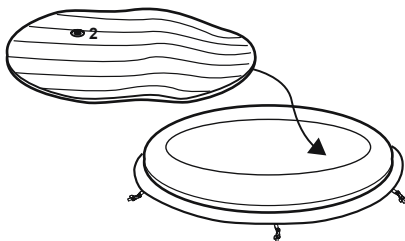

6

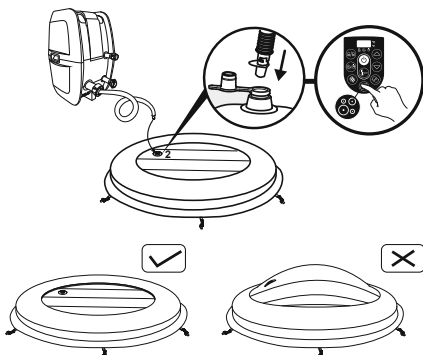

7

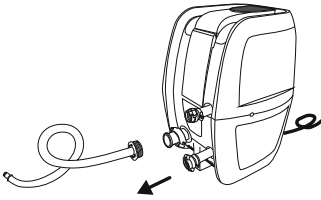

8

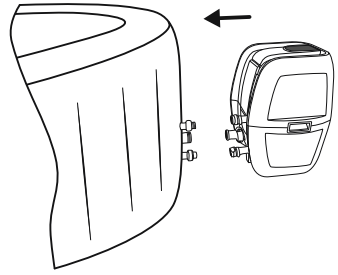

9

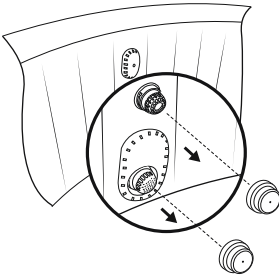

10

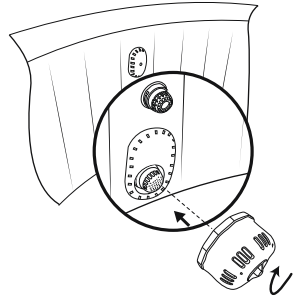

11.1



11.2 HOLLYWOOD

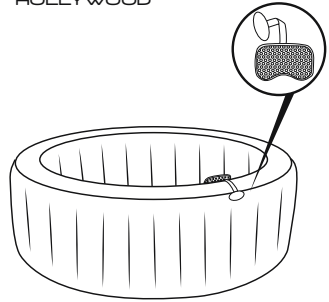

### TEST GFCI

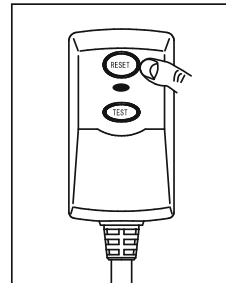
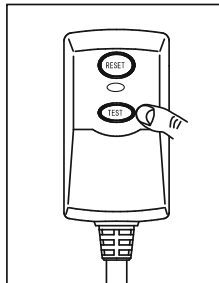
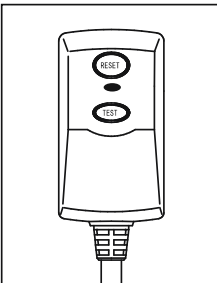

Quand vous gonflerez, vous remarquerez que l'air sera expulsé de l'endroit où le tuyau d'air est raccordé à la pompe, c'est normal pour des exigences techniques.

**Important** : ne couvrez pas les trous sur la base du tuyau de gonflage. Cette opération provoquera un surgonflage de la bâche et endommagera la structure.

N'utilisez pas de compresseur à air pour gonfler la piscine. Ne traînez pas la piscine sur un sol accidenté car cela peut endommager la bâche de la piscine.

Le temps de gonflage n'est fourni qu'à titre de référence.

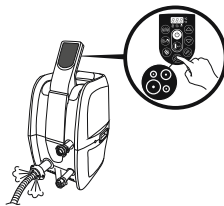

### Vérification de la valve (pour le spa avec une valve de gonflage/dégonflage rapide)

Vérifiez toujours soigneusement la valve avant de gonfler pour vous assurer qu'il n'y ait pas de fuite d'air. Si la valve est desserrée, serrez-vous de la clé fournie avec pour serrer la valve en suivant ces étapes :

D'une main, tenez l'arrière de la valve de l'intérieur de la paroi du spa et tournez la clé dans le sens des aiguilles d'une montre.

#### REMARQUE :

1. Ne serrez pas trop.

2. Ne réglez pas le connecteur de la vanne d'air quand vous utilisez le spa.

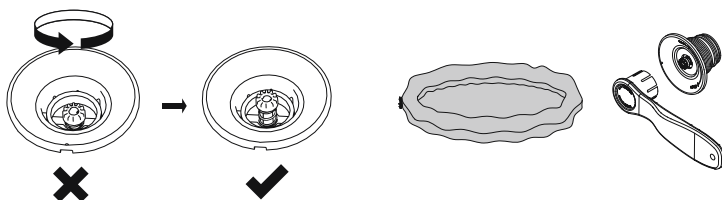

# UTILISATION DU SPA

L'hyperthermie se produit quand la température du corps dépasse de plusieurs degrés la température normale du corps qui est de 98,6°F(37°C). Les symptômes d'hyperthermie comprennent augmentation de la température du corps, vertige, léthargie, somnolence et évanouissement. Les effets de l'hyperthermie comprennent l'incapacité de ressentir la chaleur, l'incapacité de comprendre qu'il est nécessaire de sortir du spa ou du bain chaud, l'ignorance du risque imminent, des dommages pour le fœtus chez les femmes enceintes, l'incapacité physique de sortir du spa ou du bain chaud et l'inconscience pouvant entraîner la noyade.

**ATTENTION** — La consommation d'alcool, de drogues ou de médicaments peut augmenter considérablement le risque d'hyperthermie mortelle.

**ATTENTION** : LA TEMPÉRATURE DE L'EAU DÉPASSANT 100°F (38°C) PEUT ÊTRE DANGEREUSE POUR VOTRE SANTÉ.

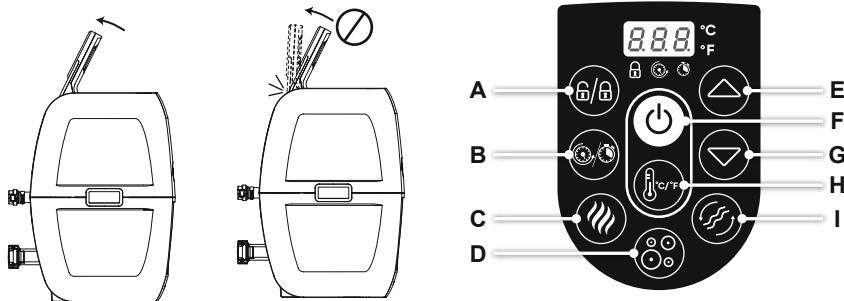

**A. BOUTON DE VERROUILLAGE/DÉVERROUILLAGE** : la pompe a un verrouillage automatique de 5 minutes, ce voyant s'allumera. Pour verrouiller ou déverrouiller la pompe, placez un doigt sur le bouton de verrouillage/déverrouillage pendant 3 secondes.



**B. BOUTON MINUTERIE ÉCONOMIE D'ÉNERGIE** : conçu pour éviter de gaspiller de l'énergie en réglant l'heure et la durée du cycle de chauffage du spa. Ceci vous permettra de profiter de votre spa quand vous le souhaitez sans avoir à laisser le chauffage allumé en permanence.

ÉTAPE N° 1 : Définissez la durée de chauffage

1. Appuyez sur le bouton ajoutez le la LED commence à clignoter.
2. Appuyez sur le bouton ou pour régler la durée de chauffage (de 1 à 999 heures).
3. Appuyez à nouveau sur le bouton pour confirmer la durée du chauffage.

ÉTAPE N° 2 : Définissez dans combien d'heures À PARTIR DE MAINTENANT le chauffage doit s'activer

1. Après avoir réglé la durée de chauffage, la LED commence à clignoter.
  2. Appuyez sur les boutons ou pour ajuster les heures jusqu'au moment de l'activation (de 0 à 999 heures).
  3. Appuyez à nouveau sur le bouton ou ne touchez rien pendant 10 secondes pour valider la configuration. La LED s'allumera en continu et le compte à rebours jusqu'à l'activation du chauffage commencera.
- Pour modifier les paramètres de la minuterie : appuyez sur le bouton et utilisez le bouton ou pour procéder au réglage. Annulez le paramètre : appuyez sur le bouton pendant 2 secondes.

**REMARQUE** : après avoir effectué le réglage, l'écran affiche alternativement la température actuelle et l'heure.

**REMARQUE** : la minuterie (durée pendant laquelle le chauffage est ACTIVÉ) peut être réglée entre 1 et 999 heures ; le réglage du temps de réservation (le nombre d'heures À PARTIR DE MAINTENANT, lorsque l'appareil de chauffage commencera à fonctionner) peut être réglé de 0 à 999 heures. Si la minuterie est réglée sur 0 heure, le système de chauffage se déclenchera immédiatement.

Notez que la minuterie n'est valable qu'une fois par utilisation : l'utilisateur règle la durée du cycle de chauffage et le nombre d'heures jusqu'au moment où le cycle de chauffage commencera. La minuterie NE SE répète PAS tant qu'elle n'est pas réinitialisée.



**C. BOUTON DE CHAUFFAGE** : utilisez ce bouton pour activer le système de chauffage. Quand le voyant au-dessus du bouton du chauffage est rouge, le système de chauffage est activé. Quand le voyant est vert, l'eau se trouve à la température configurée et le système de chauffage est à l'arrêt.

**REMARQUE** : si le système de chauffage est activé, le système de filtration démarrera automatiquement.

**REMARQUE** : après avoir éteint le système de chauffage, le système de filtration continuera à fonctionner.

**REMARQUE** : si le chauffage du spa est allumé lorsque la température de l'eau est inférieure à 42,8°F (6°C), le système de chauffage chauffera l'eau automatiquement jusqu'à 50°F (10°C).



**D. BOUTON DU SYSTÈME DE MASSAGE** : utilisez ce bouton pour activer le système de massage, qui a une fonction de coupure automatique de 30 minutes. Le voyant situé au-dessus du bouton du système de massage devient rouge quand il est activé.

**IMPORTANT** : ne faites pas fonctionner le système de massage quand la bêche est fixée. De l'air peut s'accumuler à l'intérieur du spa et causer des dommages irréparables à la bêche et des lésions corporelles.

**REMARQUE** : la chaleur et le système de massage collaborent pour créer une expérience de massage chaud.



**E/G. BOUTONS DE RÉGLAGE DE LA TEMPÉRATURE** : en appuyant sur les boutons pour augmenter ou diminuer la température, la LED se mettra à clignoter. Quand elle clignote, vous pouvez régler la température souhaitée. Si vous maintenez ces boutons enfoncés, les valeurs augmenteront ou diminueront rapidement. La configuration de la nouvelle température souhaitée restera sur l'afficheur à LED pendant 3 secondes pour confirmer la nouvelle valeur.

**REMARQUE** : la température par défaut est de 95°F (35°C).

**REMARQUE** : le réglage de la température est compris entre 68°F (20°C) et 104°F (40°C).



**F. BOUTON MARCHE/ARRÊT** : appuyez sur ce bouton pendant 2 secondes pour activer les boutons du tableau de commande et le voyant devient vert. Appuyez sur ce bouton pendant 2 secondes pour arrêter toutes les fonctions actuellement activées.



**H. COMMUTATION CELSIUS/FAHRENHEIT** : la température peut être affichée soit en Fahrenheit soit en Celsius.



**I. BOUTON DU FILTRE À EAU** : Ce bouton allume et éteint la pompe de filtration. Le voyant situé au-dessus du bouton de filtration d'eau devient rouge quand il est activé.



**LED MINUTERIE ÉCONOMIE D'ÉNERGIE** :

Le clignotement de cette LED veut dire que vous êtes en train de configurer la durée de chauffage. Le voyant sera allumé quand la fonction de chauffage commence à fonctionner.



Le clignotement de cette LED veut dire que vous êtes en train de configurer dans combien d'heures À PARTIR DE MAINTENANT le chauffage doit s'activer. Quand le voyant est allumé, la fonction minuterie économie d'énergie est configurée.

**REMARQUE** : le taux de CHAUFFAGE DE L'EAU peut changer dans les conditions ci-dessous :

- Quand la température extérieure est inférieure à 59°F (15°C).
- Si la bêche n'est pas positionnée quand on active la fonction de chauffage.

**REMARQUE** : pour afficher la température actuelle de l'eau, faites fonctionner le système de filtration pendant au moins une minute.

La température de l'eau telle qu'elle est testée par un thermomètre extérieur peut varier par rapport à la température affichée sur le tableau du spa d'environ 35,6°F (2°C).



## INSTRUCTIONS POUR L'UTILISATION EN HIVER



- Vous pouvez garder le spa allumé pendant l'hiver lorsque la température est inférieure à 42,8°F (6°C). Le système Freeze Shield™ maintient automatiquement la température de l'eau entre 42,8°F (6°C) et 50°F (10°C), et il évitera que l'eau gèle.  
**Important** : si la température de l'eau est inférieure à 42,8°F (6°C), le chauffage du spa doit toujours rester allumé. De cette manière, le système Freeze Shield™ peut maintenir la température à l'intérieur du spa entre 42,8°F (6°C) et 50°F (10°C) pour éviter les dégâts, comme par exemple l'eau gelant dans les tuyaux du système de circulation.  
**Important** : si le système Freeze Shield™ ne fonctionne pas, les alarmes se déclencheront dans le spa. Veuillez à bien vérifier l'état de votre spa si la température extérieure est inférieure à 42,8°F (6°C). En cas d'absence prolongée de votre domicile, lorsqu'il existe un risque de baisse de la température en dessous de 42,8°F (6°C), nous conseillons vivement de démonter le spa et de le ranger en suivant la procédure de rangement.
- Le client est responsable de tout dégât occasionné par l'utilisation du spa dans ces conditions. N'utilisez pas le spa quand la température ambiante atteint 14°F (-10°C).

## IMPORTANT

Pour atteindre 104°F(40°C), la durée requise de chauffage se base sur la température de l'eau au départ et sur la température ambiante, les informations fournies ci-dessous ne le sont qu'à titre de référence. Pour afficher la température actuelle de l'eau, faites fonctionner le système de filtration pendant au moins une minute.

Température ambiante	Température de l'eau	Température configurée	Durée de chauffage
50°F(10°C)	50°F(10°C)	104°F(40°C)	32 h
59°F(15°C)	59°F(15°C)	104°F(40°C)	26 h
68°F(20°C)	68°F(20°C)	104°F(40°C)	20 h
77°F(25°C)	77°F(25°C)	104°F(40°C)	14 h
86°F(30°C)	86°F(30°C)	104°F(40°C)	9 h

- Vérifiez que vous avez bien couvert le spa avec la bâche du spa quand la fonction de chauffage est activée. Si vous ne couvrez pas le spa, il faudra plus de temps pour le chauffer.
- Lorsque le spa est monté avec de l'eau, n'éteignez pas le chauffage du spa si la température est inférieure à 42,8°F (6°C).

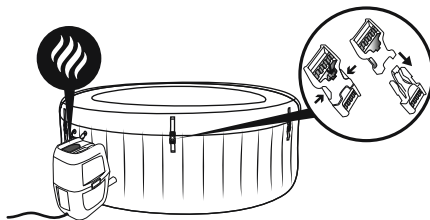

Intensité	Souffleur de tubes de massage	Élément chauffant	Pompe à eau
110-120 V CA, 60 Hz, monophasé 12 A à 20°C	6.5A	11,3 A à 20°C	0.7A

# ENTRETIEN

**ATTENTION** : vous devez vous assurer que la pompe est débranchée avant de commencer la maintenance du spa pour éviter tout risque de blessure grave, voire mortelle.

**Ajout d'air** : votre spa aura besoin d'être regonflé de temps en temps.

Les changements de température entre la nuit et le jour modifieront la pression dans le spa et pourront provoquer un certain dégonflage. Veuillez suivre les instructions de montage et le gonfler exactement à la pression nécessaire.

Lorsque vous avez besoin d'utiliser la pompe pour le gonflage, veuillez bloquer les tuyaux pour empêcher que l'eau ne s'échappe, puis débranchez la pompe, vissez le bouchon (P00217) dessus pour éviter que l'eau s'échappe par le tuyau d'air.

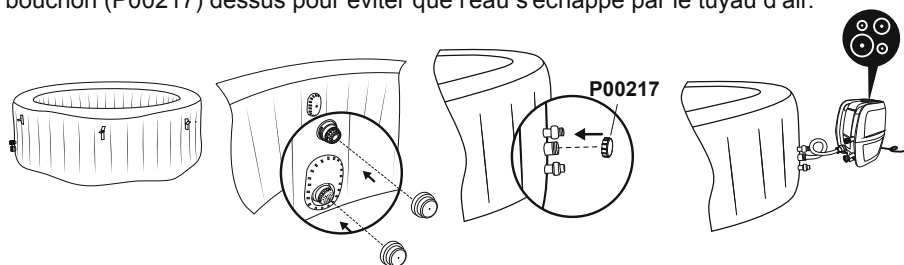

## Maintenance de la bâche

L'intérieur et l'extérieur de la bâche doivent être nettoyés régulièrement avec une solution appropriée qui comprend une désinfection appropriée (par exemple 10 mg/l de chlore libre).

## Maintenance de la cartouche de filtration

Pour être certain que l'eau de votre spa reste propre, contrôlez et nettoyez les cartouches de filtration tous les jours en suivant la procédure ci-dessous.

**REMARQUE** : nous recommandons de changer les cartouches de filtration toutes les semaines. Si les cartouches de filtration sont sales et décolorées, il faut les remplacer.

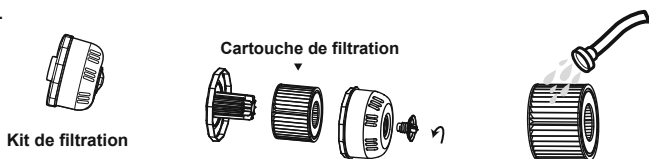

## Maintenance de l'eau

De nombreux polluants dans l'eau se déposent sur les surfaces en dessous de la ligne d'eau. Ces polluants peuvent provoquer un développement des bactéries, des algues ou des champignons. Il est recommandé de nettoyer les spas aussi souvent que cela est nécessaire. Au bout d'un certain temps, des taches tenaces ou des biofilms peuvent se développer sur les surfaces accessibles en dessous de la ligne d'eau ou de fortes concentrations de sels ou une réaction indésirable de sous-produits peuvent également se produire. En fonction des conditions d'hygiène, de la propreté, de la visibilité, des odeurs, des débris et des taches, il est recommandé de changer toute l'eau et de nettoyer/désinfecter le spa. Lorsque vous videz le spa, vous devez respecter les réglementations et les instructions de vidange de l'eau. Il est nécessaire de conserver l'eau de votre spa propre et chimiquement équilibrée. Il ne suffit pas de nettoyer la cartouche de filtration pour une

maintenance correcte, nous vous recommandons d'utiliser des produits chimiques pour piscine afin de maintenir les propriétés chimiques de l'eau et des comprimés de chlore ou de brome (n'utilisez pas de granulés) avec le distributeur chimique. La qualité de l'eau sera directement liée à la fréquence d'utilisation, au nombre d'utilisateurs et à l'entretien général du spa. Il faut changer l'eau tous les 3 jours si aucun traitement chimique n'est effectué. Il est vivement recommandé d'utiliser de l'eau du robinet pour remplir le spa, afin de réduire au minimum l'influence d'un contenu indésirable, comme par exemple des minéraux. Les zones où vous circulez pieds nus et les espaces de détente doivent également être nettoyés. Aucune eau de nettoyage ne doit pénétrer dans le spa ni dans le cycle d'eau du spa. La saleté et les produits de nettoyage doivent être soigneusement rincés pour vidanger le pourtour du spa.

**Remarque :** nous vous conseillons vivement de prendre une douche avant d'utiliser votre SaluSpa car les cosmétiques, lotions et autres résidus présents sur la peau peuvent détériorer rapidement la qualité de l'eau. Pour utiliser le distributeur de produits chimiques, veuillez suivre les instructions ci-dessous.

### Utilisation de comprimés chimiques (non inclus) :

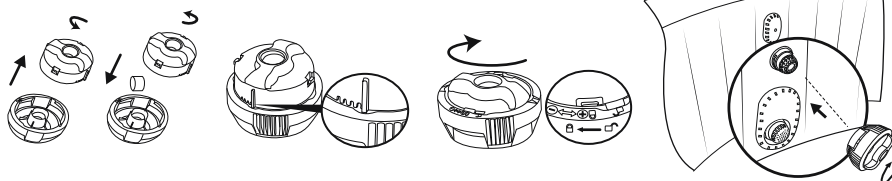

**Important :** n'utilisez pas de comprimés en granulés et ne jetez pas le comprimé directement dans l'eau. Le produit chimique se déposera au fond et endommagera le matériau et décolorera le PVC.

### Utilisation de liquide chimique (non inclus) :

**Important :** ajoutez le liquide chimique en petites doses et au centre du spa, évitez tout contact direct entre le produit chimique et la surface du spa. Tout contact direct peut endommager le matériau et décolorer la surface.

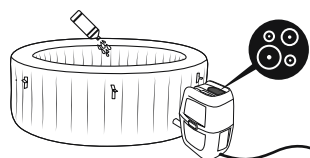

**REMARQUE :** sortez le distributeur de produits chimiques du spa quand vous utilisez le spa.

**IMPORTANT :** après avoir effectué le traitement chimique et avant d'utiliser le spa, servez-vous d'un kit d'essai (non fourni avec) pour tester les propriétés chimiques de l'eau. Nous conseillons de maintenir votre eau conformément au tableau ci-dessous.

pH	Basicité totale	Chlore libre
7.4-7.6	80-120ppm	2-4ppm

**REMARQUE :** la garantie ne couvre pas les dégâts provoqués par un déséquilibre chimique. Les produits chimiques pour piscine sont potentiellement toxiques et doivent être manipulés en faisant attention. Il existe des risques sérieux pour la santé dérivant des vapeurs chimiques ainsi que de l'étiquetage et du stockage incorrects des récipients chimiques. Veuillez vous adresser au concessionnaire de piscine le plus proche pour plus d'informations au sujet de la maintenance chimique. Lisez attentivement les instructions du producteur de produits chimiques. La garantie ne couvre pas les dégâts occasionnés au spa suite à une utilisation incorrecte des produits chimiques et à une mauvaise gestion de l'eau du spa.

**Important :** l'utilisation excessive de produits chimiques peut décolorer l'imprimé et tous les points du matériau de la piscine, dans les cas les plus graves, ils peuvent endommager la structure du liner du spa.

# DÉMONTAGE ET RANGEMENT

## VIDANGE DU SPA

1.

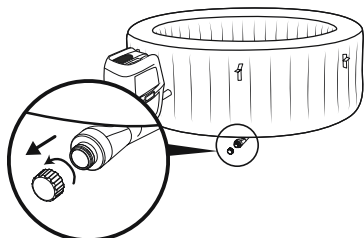

2.

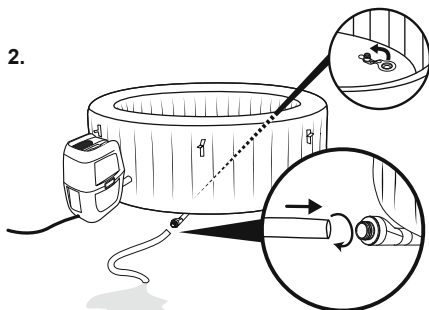

3. **REMARQUE :**  
séchez la piscine spa.

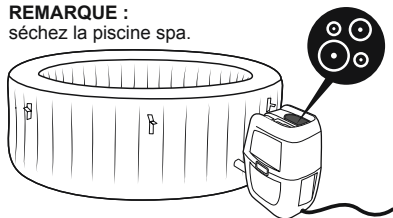

4.

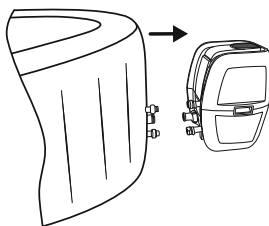

5.

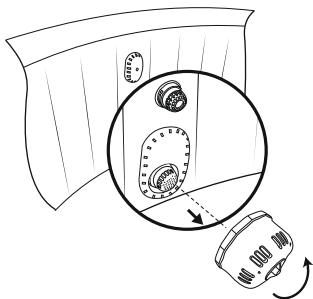

6.

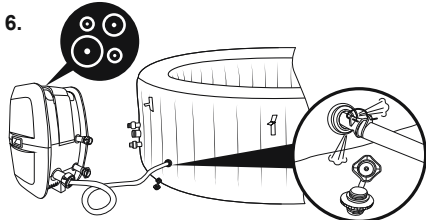

Pour les spas Bali et Hollywood :  
Vous pourriez trouver de la vapeur à l'intérieur de la chambre à air et de la moisissure peut apparaître après le rangement s'il y a de l'eau à l'intérieur. Veuillez dévisser la valve et utiliser le tuyau pour souffler dans la chambre à air jusqu'à ce que toute la vapeur à l'intérieur ait séché. Cette opération peut prendre 2 à 5 heures.

## Uniquement pour le spa en Drop Stitch™

1.



2.

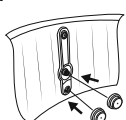

3.

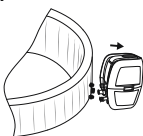

4.

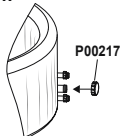

5.

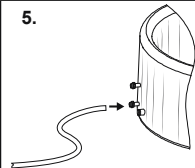

6.

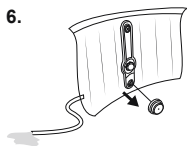

7.

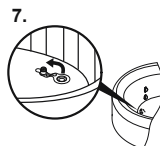

**REMARQUE :** soulevez le spa quand il ne reste qu'un peu d'eau dedans. Les dommages aux poignées ne sont pas couverts par la garantie.

8. **REMARQUE :**  
séchez la piscine spa

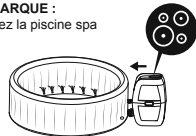

Vérifiez que le spa et la pompe soient complètement secs. Ceci est fondamental pour prolonger la durée de vie du spa. Nous vous recommandons d'utiliser la pompe pour sécher le spa, la pompe et les tuyaux. Enlevez les kits de filtration et jetez les cartouches de filtration usées. Placez à nouveau les deux bouchons d'obturation sur les vannes d'entrée et de sortie du spa. Il est recommandé de ranger le spa dans son emballage d'origine, au chaud [température supérieure à 59°F (15°C)] et au sec.

## NETTOYAGE DU SPA

Les résidus de détergent et les matières dissoutes provenant des maillots de bain et des produits chimiques peuvent s'accumuler sur les parois du spa. Utilisez du savon et de l'eau pour nettoyer les parois et rincez bien.

**REMARQUE :** N'UTILISEZ PAS de brosses dures ni de produits d'entretien abrasifs.

## DÉGONFLAGE

Votre spa est équipé d'une fonction de dégonflage pour éliminer toute l'air qui se trouve à l'intérieur de la chambre, afin de simplifier l'opération d'emballage et de rangement.

Soupape à vis 

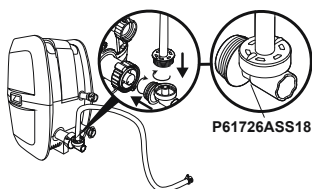

P61726ASS18

P61727ASS18

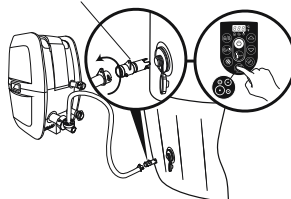

Valve de gonflage/dégonflage rapide 

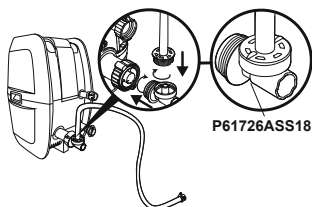

P61726ASS18

P05344

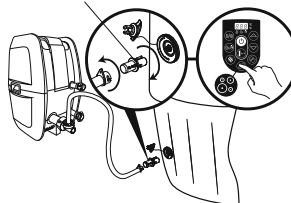

## RÉPARATION

### Pour une pièce en PVC.

Si le spa est déchiré ou percé, réparez-le avec la rustine adhésive à utiliser sous l'eau fournie avec.

1. Nettoyez la zone à réparer.
2. Décollez soigneusement la rustine.
3. Appuyez la rustine sur la zone à réparer.
4. Attendez 30 secondes avant de le gonfler.



### Pour le PVC TriTech.

Si le spa est déchiré ou percé, utilisez la rustine en PVC fournie avec et la colle (non fournie) en suivant ces étapes:







1. Nettoyez et séchez la zone à réparer.
2. Coupez la rustine en PVC fournie avec à la bonne taille.
3. Mettez la colle (non fournie) sur le côté de la rustine que vous venez de couper. Vérifiez que la colle soit distribuée uniformément.
4. Attendez 30 secondes avant de placer la rustine avec la colle sur la zone endommagée.
5. Lissez pour éliminer les bulles d'air qui pourraient s'être formées et appuyez dessus fermement pendant deux minutes.
6. Vous pouvez désormais utiliser à nouveau le produit. Répétez cette opération si vous découvrez d'autres fuites.
7. Attendez 30 minutes avant de le gonfler.

# DÉPANNAGE

Bestway s'efforce de fournir les spas les plus performants sur le marché. Si vous rencontrez néanmoins des problèmes, n'hésitez pas à contacter Bestway ou votre revendeur agréé. Voici quelques astuces utiles pour vous aider à faire un diagnostic et à résoudre les sources de problèmes les plus courantes.

Problèmes	Éventuelles causes	Solutions
La pompe ne fonctionne pas	<ul style="list-style-type: none"> <li>- Panne de courant</li> <li>- GFCI cassé</li> </ul>	<ul style="list-style-type: none"> <li>- Vérifier la source d'alimentation</li> <li>- Si vous avez besoin d'aide, veuillez visiter la section assistance de notre site web, <a href="http://www.bestwaycorp.com">www.bestwaycorp.com</a></li> </ul>
La pompe ne chauffe pas correctement	<ul style="list-style-type: none"> <li>- La température réglée est trop basse</li> <li>- La cartouche du filtre est sale</li> <li>- Le coupe-circuit thermique s'arrête</li> <li>- Le spa n'est pas couvert</li> <li>- Panne de l'élément de chauffage</li> </ul>	<ul style="list-style-type: none"> <li>- Réglez une température supérieure, reportez-vous au paragraphe relatif au fonctionnement de la pompe</li> <li>- Nettoyez/remplacez la cartouche du filtre, reportez-vous au paragraphe relatif au nettoyage et au remplacement de la cartouche du filtre</li> <li>- Ajoutez de l'eau jusqu'aux niveaux indiqués</li> <li>- Débranchez la pompe et placez la fiche au frais et au sec. Ne redémarrez la pompe que quand la température de l'eau est inférieure ou égale à 35°C (95°F)</li> <li>- Fixez la bâche</li> <li>- Si vous avez besoin d'aide, veuillez visiter la section assistance de notre site web, <a href="http://www.bestwaycorp.com">www.bestwaycorp.com</a></li> </ul>
Le système massage ne fonctionne pas	<ul style="list-style-type: none"> <li>- La pompe à air surchauffe est trop chaude</li> <li>- E massage s'arrête automatiquement</li> <li>- La pompe à air est cassée</li> </ul>	<ul style="list-style-type: none"> <li>- Débranchez la pompe et attendez deux heures afin que la pompe refroidisse. Branchez la fiche et appuyez sur le Bouton du système massage</li> <li>- Appuyez sur le bouton du système massage pour le réactiver</li> <li>- Si vous avez besoin d'aide, veuillez visiter la section assistance de notre site web, <a href="http://www.bestwaycorp.com">www.bestwaycorp.com</a></li> </ul>
Les adaptateurs de la pompe ne sont pas au même niveau que les adaptateurs du spa	<ul style="list-style-type: none"> <li>- La nature du PVC l'amène à changer de forme, ce qui est normal</li> </ul>	<ul style="list-style-type: none"> <li>- Réhaussez la pompe avec du bois ou un autre type de matériau isolé pour amener les adaptateurs de la pompe au niveau des adaptateurs du spa</li> </ul>
Fuite au niveau de la piscine spa	<ul style="list-style-type: none"> <li>- Le spa est déchiré ou percé</li> <li>- La vanne d'air est desserrée</li> </ul>	<ul style="list-style-type: none"> <li>- Utilisez la rustine fournie avec</li> <li>- Recouvrez la vanne d'air avec de l'eau savonneuse pour vérifier s'il y a une fuite d'air. Si c'est le cas, utilisez la clé fournie avec pour serrer la vanne d'air selon la procédure suivante :             <ol style="list-style-type: none"> <li>1. Dégonflez le SPA.</li> <li>2. D'une main, tenez le côté arrière de la vanne d'air de l'intérieur de la paroi du spa et tournez la clé dans le sens des aiguilles d'une montre.</li> </ol> </li> </ul>
L'eau n'est pas propre	<ul style="list-style-type: none"> <li>- Temps de filtration insuffisant</li> <li>- La cartouche du filtre est sale</li> <li>- Entretien incorrect de l'eau</li> </ul>	<ul style="list-style-type: none"> <li>- Augmentez le temps de filtration</li> <li>- Nettoyez/remplacez la cartouche du filtre (reportez-vous au paragraphe relatif au nettoyage et au remplacement de la cartouche du filtre)</li> <li>- Reportez-vous aux instructions du producteur des produits chimiques</li> </ul>
Le tableau de commande ne fonctionne pas	<ul style="list-style-type: none"> <li>- Le tableau de commande dispose d'un verrouillage automatique, qui est activé après 5 minutes d'inactivité. L'affichage à LED présente une icône.  Si l'icône de verrouillage est en surbrillance, le tableau de commande est verrouillé</li> <li>- Le tableau de commande n'est pas activé.</li> </ul>	<ul style="list-style-type: none"> <li>- Pour déverrouiller le tableau de commande, appuyez sur le bouton  pendant 3 secondes. Si le tableau de commande ne se déverrouille pas, redémarrez la pompe - débrancher et rebrancher la pompe.</li> <li>- Appuyez sur le bouton marche/arrêt pendant 2 secondes. Si le problème persiste, Si vous avez besoin d'aide, veuillez visiter la section assistance de notre site web, <a href="http://www.bestwaycorp.com">www.bestwaycorp.com</a></li> </ul>
Le test GFCI a échoué	<p>Votre Spa présente un défaut</p>	<p>Si vous avez besoin d'aide, veuillez visiter la section assistance de notre site web, <a href="http://www.bestwaycorp.com">www.bestwaycorp.com</a></p>
Quel genre de produits chimiques doivent être utilisés pour l'entretien de l'eau ?	<p>Veuillez consulter votre revendeur local de produits chimiques pour obtenir plus d'informations relatives à l'entretien chimique. Porter une attention particulière aux instructions du fabricant de produits chimiques.</p>	
L'eau fuit des adaptateurs entre la pompe et le spa	<ul style="list-style-type: none"> <li>- Des joints sont manquants à l'intérieur des adaptateurs de la pompe</li> <li>- Les joints ne sont pas dans la bonne position</li> <li>- Les joints sont endommagés.</li> <li>- Les adaptateurs ne sont pas serrés correctement.</li> </ul>	<ul style="list-style-type: none"> <li>- Placez les bouchons d'obturation sur les orifices du spa pour éviter que l'eau s'échappe et débranchez la pompe. Vérifiez que tous les joints sont à leur place.</li> <li>- Si les joints ne sont pas dans la bonne position, ouvrez les équipements et placez les joints dans la bonne position.</li> <li>- Si les joints sont endommagés, il faut les remplacer.</li> <li>- Si les joints sont dans la bonne position, les adaptateurs ne sont pas serrés correctement. Raccordez la pompe au spa, serrez les adaptateurs à la main et ôtez les bouchons d'obturation des orifices du spa. En cas de fuite, serrez l'adaptateur jusqu'à ce que la fuite cesse.</li> </ul>

# CODES D'ERREUR

CAUSES	MOTIFS	SOLUTIONS
<p>Les capteurs du débit d'eau fonctionnent sans appuyer sur le bouton du filtre ou de chauffage.</p> 	<ol style="list-style-type: none"> <li>1. Les bannières des capteurs du débit d'eau ne sont pas retournées dans la position correcte.</li> <li>2. Les capteurs du débit d'eau sont cassés.</li> </ol>	<ol style="list-style-type: none"> <li>1. Débranchez la fiche délicatement, donnez un coup léger sur le côté de la pompe et rebranchez-la.</li> <li>2. Si vous avez besoin d'aide, veuillez visiter la section assistance de notre site web, <a href="http://www.bestwaycorp.com">www.bestwaycorp.com</a></li> </ol>
<p>Après le démarrage ou durant les fonctions de filtration e/ou de chauffage, les capteurs du débit d'eau ne détectent pas le débit d'eau.</p> 	<ol style="list-style-type: none"> <li>1. Vous avez oublié d'enlever les 3 bouchons d'obturation de l'intérieur de la piscine.</li> <li>2. Les cartouches des filtres sont sales</li> <li>3. Déclenchez le filtre ou le système de chauffage et placez votre main en face du tuyau de sortie à l'intérieur de la piscine pour vérifier que vous sentez le flux d'eau qui sort.             <ol style="list-style-type: none"> <li>a. Si l'eau ne s'écoule pas, la pompe à eau est cassée</li> <li>b. L'eau s'écoule mais l'alarme  s'affiche Les capteurs du débit d'eau sont cassés.</li> </ol> </li> <li>4. Obstruction du filtre,</li> <li>5. Tuyaux tordus ou mauvais débit d'eau à travers les tuyaux en plastique du liner</li> <li>6. Les grilles sont obstruées : les grilles peuvent se retrouver bloquées par de l'eau dure en raison de l'accumulation du calcium.</li> <li>7. Rondelles détériorées Les rondelles à l'intérieur des raccords du spa peuvent être détériorées ou usées.</li> </ol>	<ol style="list-style-type: none"> <li>1. Enlevez les 3 bouchons d'obturation avant de chauffer, reportez-vous au paragraphe Montage dans la notice d'utilisation.</li> <li>2. Enlevez le groupe de filtration de l'intérieur de la piscine et appuyez sur le bouton du filtre ou de chauffage. Si aucune alarme n'apparaît, nettoyez ou changez les cartouches du filtre, installez le groupe de filtration à l'intérieur de la piscine.</li> <li>3. Si vous avez besoin d'aide, veuillez visiter la section assistance de notre site web, <a href="http://www.bestwaycorp.com">www.bestwaycorp.com</a></li> <li>4. Nettoyez le filtre et vérifiez qu'il n'est pas endommagé. Remplacez-le ou réinstallez-le si nécessaire. Si vous avez besoin d'aide, veuillez visiter la section assistance de notre site web, <a href="http://www.bestwaycorp.com">www.bestwaycorp.com</a></li> <li>5. Veuillez contrôler à travers le raccordement du spa pour voir si les tuyaux sont tordus. Si vous avez besoin d'aide, veuillez visiter la section assistance de notre site web, <a href="http://www.bestwaycorp.com">www.bestwaycorp.com</a></li> <li>6. Videz le spa et placez un tuyau d'arrosage à l'intérieur des tuyaux pour rincer la grille. Pour être certain que tous les débris ont été éliminés, effectuez l'opération de l'extérieur et de l'intérieur du spa. Utilisez une brosse à dents pour éliminer les débris tenaces. Si vous avez besoin d'aide, veuillez visiter la section assistance de notre site web, <a href="http://www.bestwaycorp.com">www.bestwaycorp.com</a></li> <li>7. Vérifiez l'état des rondelles à l'intérieur du raccord. Dévissez les raccords et enlevez la rondelle pour mieux l'inspecter. Si vous avez besoin d'aide, veuillez visiter la section assistance de notre site web, <a href="http://www.bestwaycorp.com">www.bestwaycorp.com</a></li> </ol>
<p>Le thermomètre de la pompe indique une température de l'eau inférieure à 40°F (4°C).</p> 	<ol style="list-style-type: none"> <li>1. La température de l'eau est inférieure à 40°F (4°C).</li> <li>2. Si la température de l'eau est supérieure à 44,6°F (7°C), le thermomètre de la pompe est cassé.</li> </ol>	<ol style="list-style-type: none"> <li>1. Le spa n'est pas conçu pour fonctionner avec des températures de l'eau inférieures à 40°F (4°C). Débranchez la pompe et ne redémarrez la pompe que quand la température de l'eau atteint 43°F (6°C).</li> <li>2. Si vous avez besoin d'aide, veuillez visiter la section assistance de notre site web, <a href="http://www.bestwaycorp.com">www.bestwaycorp.com</a></li> </ol>
<p>Le thermomètre de la pompe indique une température de l'eau supérieure à 119°F (48°C).</p> 	<ol style="list-style-type: none"> <li>1. La température de l'eau est supérieure à 119°F (48°C).</li> <li>2. La température ambiante est supérieure à 104°F (40°C) ou le spa se trouve en plein soleil pendant une longue période.</li> <li>3. Si la température de l'eau est inférieure à 45°C (113°F), le thermomètre de la pompe est cassé.</li> </ol>	<ol style="list-style-type: none"> <li>1. Le spa n'est pas conçu pour fonctionner avec des températures de l'eau supérieures à 104°F (40°C). Débranchez la pompe et ne redémarrez la pompe que quand la température de l'eau est inférieure ou égale à 100°F (38°C).</li> <li>2. Débranchez la fiche, détachez la pompe et vidangez le spa. Au bout de 15 minutes, attachez à nouveau la pompe, rebranchez la fiche et redémarrez la fonction de chauffage. Si l'alarme s'affiche à nouveau, envisagez de déplacer le spa à un autre endroit qui ne soit pas en plein soleil.</li> <li>3. Si vous avez besoin d'aide, veuillez visiter la section assistance de notre site web, <a href="http://www.bestwaycorp.com">www.bestwaycorp.com</a></li> </ol>
<p>Il y a des problèmes au niveau des branchements du thermomètre de la pompe.</p> 	<ol style="list-style-type: none"> <li>1. Les raccords du thermomètre de la pompe ne fonctionnent pas correctement.</li> <li>2. Le thermomètre de la pompe est cassé.</li> </ol>	<p>Si vous avez besoin d'aide, veuillez visiter la section assistance de notre site web, <a href="http://www.bestwaycorp.com">www.bestwaycorp.com</a></p>
<p>L'arrêt du coupe-circuit thermique.</p> 	<ol style="list-style-type: none"> <li>1. La température ambiante est supérieure à 122°F (50°C) ou la pompe se trouve en plein soleil</li> <li>2. The thermal cut-out is broken.</li> </ol>	<ol style="list-style-type: none"> <li>1. Débranchez la pompe et placez la fiche au frais et au sec. Ne redémarrez la pompe que quand la température de l'eau est inférieure ou égale à 93,2°F (34°C).</li> <li>2. Si vous avez besoin d'aide, veuillez visiter la section assistance de notre site web, <a href="http://www.bestwaycorp.com">www.bestwaycorp.com</a></li> </ol>





# SALUSPA<sup>®</sup>

**Bestway**

# CONTENIDO

---

<b>INSTRUCCIONES DE SEGURIDAD IMPORTANTES</b>	<b>pg 059</b>
<b>LISTA DE VERIFICACIÓN ANTES DE LA INSTALACIÓN</b>	<b>pg 063</b>
<b>INSTALACIÓN</b>	<b>pg 071</b>
<b>INSTRUCCIONES PARA USO EN INVIERNO</b>	<b>pg 071</b>
<b>USO DEL SPA</b>	<b>pg 075</b>
<b>MANTENIMIENTO</b>	<b>pg 078</b>
<b>DESMONTAJE Y ALMACENAMIENTO</b>	<b>pg 080</b>
<b>RESOLUCIÓN DE PROBLEMAS</b>	<b>pg 082</b>
<b>CÓDIGOS DE ERROR</b>	<b>pg 083</b>

---



**VISITE EL CANAL DE YOUTUBE DE BESTWAY**

**VEA LOS VÍDEOS DE INSTRUCCIONES EN BESTWAYCORP.COM/SUPPORT**

# INSTRUCCIONES DE SEGURIDAD IMPORTANTES

## ADVERTENCIAS INSTRUCCIONES DE SEGURIDAD IMPORTANTES

Durante el manejo de este aparato eléctrico, han de respetarse las precauciones de seguridad básicas, entre las que se incluyen las siguientes:

### LEA Y RESPETE TODAS LAS INSTRUCCIONES.

**ADVERTENCIAS** – Para reducir el riesgo de lesiones, no permita que los niños utilicen este producto si no están estrechamente vigilados en todo momento.

En esta unidad, se incluye un conector de cable para conectar un conductor de cobre macizo de 6 AWG (13,3 mm<sup>2</sup>) entre esta unidad y cualquier equipo de metal, carcasa de metal con equipos eléctricos, tubería o conducto de agua de metal en un radio de 1,5 m de la unidad.

**PELIGRO** – Riesgo de lesiones.

- a) Cambie cualquier cable dañado de inmediato.
- b) No entierre cables.
- c) Conectar únicamente a una clavija con toma de tierra.

**ADVERTENCIAS** – Este producto incluye un interruptor del circuito de fallos de conexión a tierra integrado en el enchufe en el extremo del cable. La protección GFCI debe comprobarse antes de cada uso. Con el producto en funcionamiento, pulse el botón de prueba en la toma GFCI y el producto no debería ponerse en marcha. Pulse el botón de reinicio en la toma GFCI y ahora el producto debería funcionar normalmente. Cuando el producto no funciona de este modo, existe un flujo de corriente a tierra que indica la posibilidad de que se produzca una descarga eléctrica. Desconecte la alimentación hasta que el fallo haya sido identificado y subsanado.

**PELIGRO** – Riesgo de Ahogamiento Accidental. Deben adoptarse todas las precauciones necesarias para evitar que los niños accedan al aparato sin permiso. Para evitar accidentes, asegúrese de que los niños no pueden usar esta sauna si no están vigilados en todo momento.

**PELIGRO** – Riesgo de Lesiones. Los accesorios de aspiración en el spa se han dimensionado para ajustarse al caudal de agua específico generado por la bomba. En caso de que fuera necesario cambiar los accesorios de aspiración o la bomba, asegúrese de que los caudales sean compatibles. Nunca ponga en marcha el spa si los accesorios de aspiración están rotos o ausentes. Nunca cambie un accesorio de aspiración por otro con un caudal nominal inferior al indicado en el accesorio de aspiración original.

**PELIGRO** – Riesgo de Descarga Eléctrica.

Instale como mínimo a 1,5 m de cualquier superficie metálica. De manera alternativa, puede instalarse un spa a menos de 1,5 metros de cualquier superficie, si cada superficie metálica permanece permanentemente conectada a través de un conductor de cobre macizo de 6 AWG (13,3 mm<sup>2</sup>) al conector de cable en la caja de terminales suministrada a estos fines.

**PELIGRO** – Riesgo de Descarga Eléctrica. No permita la presencia aparatos eléctricos (lámparas, teléfonos, radios o tv) a menos de 1,5 m del spa.

**ADVERTENCIAS** – Para reducir el riesgo de lesiones:

- a) El agua en la sauna no debe sobrepasar los 104°F (40°C). Las temperaturas del agua comprendidas entre los 100°F (38°C) y los 40°C se consideran seguras para un adulto sano. Se recomiendan temperaturas más bajas para niños pequeños y cuando el uso de la sauna supera los 10 minutos.
- b) Dado que una temperatura del agua excesiva es potencialmente peligrosa para el feto durante los primeros meses del embarazo, las mujeres que estén embarazadas o que puedan estarlo deben limitar la temperatura del agua a 100°F (38°C).
- c) Antes de entrar en el spa, el usuario debería medir la temperatura del agua con un termómetro de

- precisión puesto que la tolerancia de los dispositivos de regulación de la temperatura del agua varía.
- d) El uso de alcohol, drogas, o medicación antes o durante la sauna puede provocar un estado de inconsciencia con la posibilidad de ahogamiento.
  - e) Las personas obesas y las personas con un historial de problemas cardíacos, presión alta o baja, problemas en el sistema circulatorio o diabetes deben consultar a su médico antes de usar una sauna.
  - f) Las personas que tomen cualquier medicación deben consultar a su médico antes de usar una sauna dado que algunos tipos de medicación producen somnolencia, mientras que otros tipos pueden afectar a la frecuencia cardíaca, presión sanguínea y circulación.

**ADVERTENCIAS:** PARA EVITAR CUALQUIER DESCARGA ELÉCTRICA, NO USE LA SAUNA SI LLUEVE.

**ADVERTENCIAS:** El agua atrae a los niños; Ponga siempre una cubierta en la sauna después de cada uso.

**ADVERTENCIAS:** PARA REDUCIR EL RIESGO DE LESIONES: Nunca agregue agua al spa con una temperatura superior a 104°F (40°C).

## CONSULTE CON SU MÉDICO PARA OTRAS RECOMENDACIONES.

### PRECAUCIÓN:

Recomendamos encarecidamente no desplegar ni inflar el spa si la temperatura ambiente es inferior a 59°F(15°C ). Sugerimos inflar el spa en el interior y luego continuar con la instalación en el exterior. Si la temperatura exterior es inferior a , el calentador del spa debe estar siempre encendido. En este modo, el sistema Freeze Shield™ puede mantener la temperatura interna entre 42,8°F(6°C ) y 50°F (10°C) para evitar daños, como la congelación del agua en las tuberías o en el sistema de circulación.

**IMPORTANTE:** si el sistema Freeze Shield™ no funciona, aparecerán alarmas en el spa. Asegúrese de verificar el estado de su spa si la temperatura exterior es inferior a 42,8°F (6°C). En caso de una ausencia prolongada en el hogar cuando existe el riesgo de que las temperaturas caigan por debajo de los 42,8°F (6°C), sugerimos encarecidamente desmontar el spa y almacenarlo como se indica.

**PRECAUCIÓN:** No use la sauna solo.

**PRECAUCIÓN:** Entre y salga de la sauna siempre lenta y cuidadosamente. Las superficies mojadas resbalan.

**PRECAUCIÓN:** Para evitar daños a la bomba, la sauna no deben funcionar nunca si no está llena de agua.

**PRECAUCIÓN:** Salga inmediatamente de la sauna si no se siente bien o si tiene sueño.

**NOTA:** Por favor, revise el equipamiento antes del uso. Notifique al servicio al cliente de Bestway en la dirección indicada en este manual cualquier pieza que falte o esté dañada en el momento de la compra. Compruebe que los componentes del equipamiento son el modelo que usted quería comprar.

## GUARDE ESTE MANUAL DE INSTRUCCIONES

**ADVERTENCIAS:** LOS NIÑOS NO DEBERÍAN UTILIZAR SPAS O JACUZZIS SIN LA SUPERVISIÓN DE UN ADULTO.

**ADVERTENCIAS:** NO USE SPAS O JACUZZIS SI NO SE HAN INSTALADO TODAS LAS PROTECCIONES DE ASPIRACIÓN PARA EVITAR QUE PARTES DEL CUERPO O EL CABELLO QUEDEN ATRAPADAS.

**ADVERTENCIAS:** AQUELLAS PERSONAS QUE ESTÉN TOMANDO MEDICACIÓN Y/ O CON UN HISTORIAL MÉDICO ADVERSO DEBERÍAN CONSULTAR A UN MÉDICO ANTES DE UTILIZAR UN SPA O JACUZZI.

**ADVERTENCIAS:** AQUELLAS PERSONAS CON ENFERMEDADES INFECCIOSAS NO DEBERÍAN UTILIZAR UN SPA O JACUZZI.

**ADVERTENCIAS:** PARA EVITAR LESIONES, EXTREME LAS PRECAUCIONES AL ENTRAR O SALIR DEL SPA O JACUZZI.

**ADVERTENCIAS:** NO CONSUMA DROGAS O ALCOHOL ANTES O DURANTE EL USO DE UN SPA O JACUZZI A FIN DE EVITAR LAS PÉRDIDAS DE CONOCIMIENTO Y LOS RIESGOS DE AHOGAMIENTO ASOCIADOS.

**ADVERTENCIAS:** LAS MUJERES EMBARAZADAS O QUE SOSPECHEN PUEDAN ESTARLO DEBEN CONSULTAR A UN MÉDICO ANTES DE USAR UN SPA O JACUZZI.

**ADVERTENCIAS:** UNA TEMPERATURA DEL AGUA SUPERIOR A 38 °C PUEDE SER PERJUDICIAL PARA LA SALUD.

**ADVERTENCIAS:** ANTES DE ENTRAR EN EL SPA O JACUZZI, MIDA LA TEMPERATURA DEL AGUA CON UN TERMÓMETRO DE PRECISIÓN.

**ADVERTENCIAS:** NO USE UN SPA O JACUZZI INMEDIATAMENTE DESPUÉS DE LA PRÁCTICA DE UNA ACTIVIDAD INTENSA.

**ADVERTENCIAS:** LA INMERSIÓN PROLONGADA EN UN SPA O JACUZZI PUEDE SER PERJUDICIAL PARA LA SALUD.

**ADVERTENCIAS:** NO PERMITA APARATOS ELÉCTRICOS (LÁMPARAS, TELÉFONOS, RADIOS O TV) A MENOS DE 1,5 M DEL SPA O JACUZZI.

**PRECAUCIÓN:** MANTENGA LOS VALORES QUÍMICOS DEL AGUA DENTRO DE LOS RANGOS ESPECIFICADOS POR EL FABRICANTE.

**MONTAJE: LA ETIQUETA DE ADVERTENCIA INCLUIDA**



# ADVERTENCIA

## PARA REDUCIR EL RIESGO DE ELECTROCUCIÓN

1. NO COLOQUE NUNCA UN APARATO ELÉCTRICO A MENOS DE 1,5 METROS DEL SPA.

## PARA EVITAR QUE LOS NIÑOS SE AHOGUEN

1. VIGILE A LOS NIÑOS EN TODO MOMENTO.

2. COLOQUE LA TAPA DEL SPA DESPUÉS DE CADA USO.

## PARA REDUCIR EL RIESGO DE SOBRECALENTAMIENTO

1. CONSULTE A SU MÉDICO ANTES DE UTILIZAR EL SPA SI ESTÁ EMBARAZADA, SUFRE DIABETES, NO GOZA DE BUENA SALUD O SE ENCUENTRA BAJO TRATAMIENTO MÉDICO.

2. SALGA DEL SPA INMEDIATAMENTE SI SE SIENTE INCÓMODO, MAREADO O ADORMILADO. EL CALOR DEL SPA PUEDE PRODUCIR HIPERTERMIA Y PÉRDIDA DE CONOCIMIENTO.

3. EL CALOR DEL SPA COMBINADO CON EL CONSUMO DE ALCOHOL, DROGAS O MEDICAMENTOS PUEDE PROVOCAR PÉRDIDA DE CONOCIMIENTO.

**SI ESTÁ EMBARAZADA,** SUMERGIRSE EN AGUA CALIENTE DURANTE MUCHO TIEMPO PUEDE DAÑAR AL FETO. CONTROLE LA TEMPERATURA DEL AGUA ANTES DE ENTRAR.

1. NO ENTRE EN EL SPA SI EL AGUA TIENE UNA TEMPERATURA SUPERIOR A 38°C.

2. NO PERMANEZCA EN EL SPA DURANTE MÁS DE 10 MINUTOS.

**NOTA: La etiqueta de advertencia debe ubicarse cerca del spa en una posición legible durante el uso del spa.**

1. Extraiga la etiqueta de advertencia del kit de accesorios.
2. Retire con cuidado el soporte de la etiqueta de advertencia.
3. Coloque la etiqueta de advertencia. Para solicitar la etiqueta de advertencia, contacte con su servicio posventa Bestway local.

## UBICACIÓN SELECCIONADA

**IMPORTANTE:** Debido al peso total del SaluSpa, el agua, y los usuarios, es extremadamente importante que la base donde se instala el SaluSpa sea suave, lisa, nivelada y capaz de soportar de manera uniforme el peso durante todo el tiempo de la instalación del SaluSpa (no en moqueta u otro material similar). Si el SaluSpa se pone en una superficie que no cumple estos requisitos, los daños causados por un soporte no adecuado no están cubiertos por la garantía del fabricante. Es responsabilidad del propietario de SaluSpa asegurar la integridad del sitio en todo momento.

### 1. Instalación en el interior:

**Tenga en cuenta estos requisitos especiales si instala la sauna en el interior.**

- La humedad es un efecto secundario a la instalación de SaluSpa. Determine los efectos de la humedad en el aire en la madera, papel, etc. expuestos en la relativa ubicación. Para minimizar estos efectos, es mejor ventilar tanto como sea posible el área seleccionada. Un arquitecto puede ayudarle a determinar si es necesaria más ventilación.

### 2. Instalación en el exterior

- Durante el llenado, vaciado o mientras se está usando, puede caer agua fuera de la sauna. Por lo tanto, el SaluSpa debe instalarse cerca de un drenaje en el suelo.
- No permita que la superficie de la sauna quede expuesta a la luz del sol directa durante un largo período de tiempo.

## ADVERTENCIA GFCI

**IMPORTANTE: RIESGO DE DESCARGA ELÉCTRICA. SE DEBE PROBAR EL GFCI ANTES DE ENCENDER LA BOMBA EN CADA USO.**

**ADVERTENCIA:** el enchufe de GFCI debe probarse antes de cada uso para evitar el riesgo de descarga eléctrica.

**ADVERTENCIA:** antes de insertar el enchufe en una toma de corriente, asegúrese de que la tasa de corriente de la toma es adecuada para la bomba.

**ADVERTENCIA:** no utilice la bomba si la prueba falla. Para recibir asistencia, visite la sección de soporte de nuestro sitio web: [www.bestwaycorp.com](http://www.bestwaycorp.com).

**ADVERTENCIA:** utilizar un alargador o un adaptador multienchufe con el calentador del spa puede provocar el sobrecalentamiento del enchufe, causando daños al equipo y los elementos circundantes. El spa es un electrodoméstico de clase I y debe conectarse directamente a una toma de corriente con conexión a tierra. Se recomienda usar una única toma de corriente resistente a la humedad y con capacidad para cargas de alta potencia. Revise el enchufe y la toma de corriente con regularidad para comprobar si hay señales de daños antes de utilizar el spa; no lo utilice si el enchufe o la toma están dañados. Si tiene dudas sobre la calidad del suministro eléctrico, consulte a un electricista cualificado antes de utilizar el spa.

# LISTA DE VERIFICACIÓN ANTES DE LA INSTALACIÓN

## COMPROBACIÓN DE PIEZAS

Examine el equipo antes de utilizarlo. Notifique al servicio de atención al cliente de Bestway® sobre cualquier pieza dañada o faltante en el momento de la compra. Verifique que los componentes del equipo se corresponden con los modelos que tenía la intención de comprar. Utilice los diagramas que figuran a continuación como referencia.

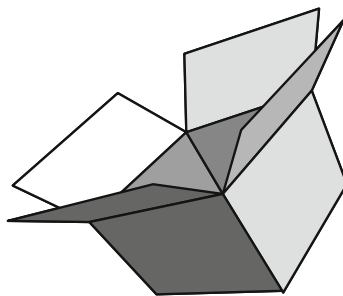

### MIAMI AIRJET S100104 (60002)

— 71" x 26" / 1.80 m x 66 cm



2 - 4



2-3°F/h  
1-1.5°C/h



320 gal/h  
1,211 L/h



0.034-0.055Bar  
0.5-0.8PSI



177 gal  
669 L



1,534 Lb  
696 kg

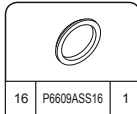
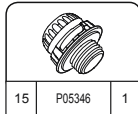
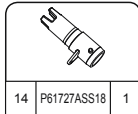
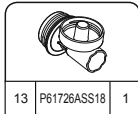
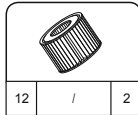
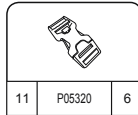
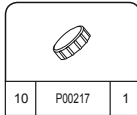
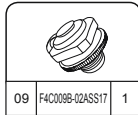
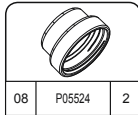
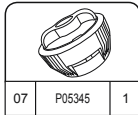
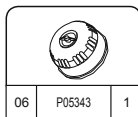
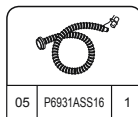
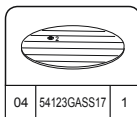
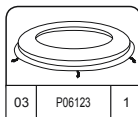
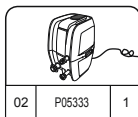
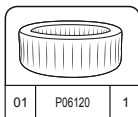

# CANCUN AIRJET S100104 (60004)

— 71" x 26" / 1.80 m x 66 cm



2 - 4



2-3°F/h  
1-1.5°C/h



320 gal/h  
1,211 L/h



0.034-0.055Bar  
0.5-0.8PSI



177 gal  
669 L



1,534 Lb  
696 kg

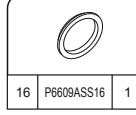
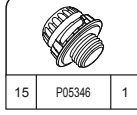
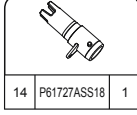
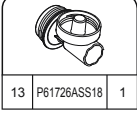
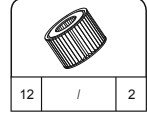
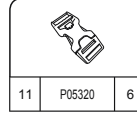
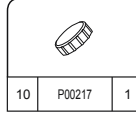
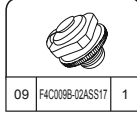
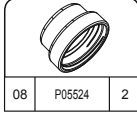
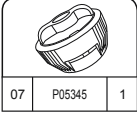
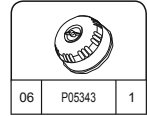
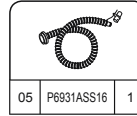
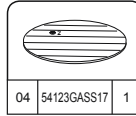
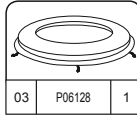
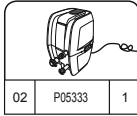
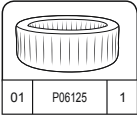

# BAHAMAS AIRJET S100104 (60006)

— 71" x 26" / 1.80 m x 66 cm



2 - 4



2-3°F/h  
1-1.5°C/h



320 gal/h  
1,211 L/h



0.034-0.055Bar  
0.5-0.8PSI



177 gal  
669 L



1,534 Lb  
696 kg

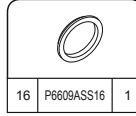
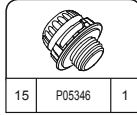
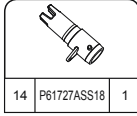
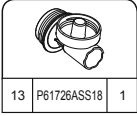
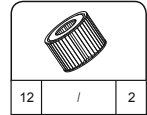
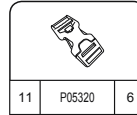
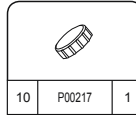
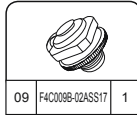
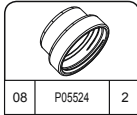
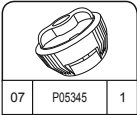
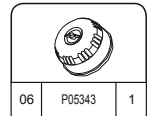
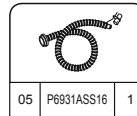
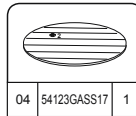
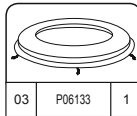
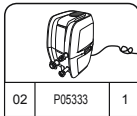
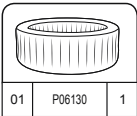



# TAHITI AIRJET S100104 (60008)

— 71" x 26" / 1.80 m x 66 cm



2 - 4



2-3°F/h  
1-1.5°C/h



320 gal/h  
1,211 L/h



0.034-0.055Bar  
0.5-0.8PSI



177 gal  
669 L



1,534 Lb  
696 kg

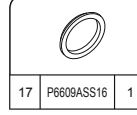
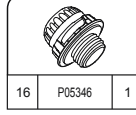
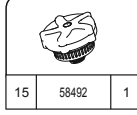
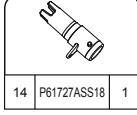
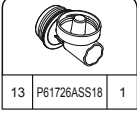
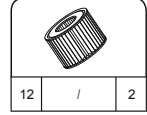
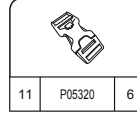
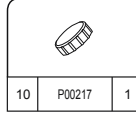
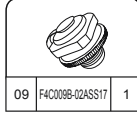
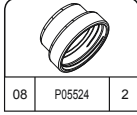
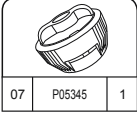
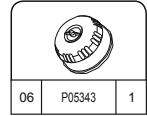
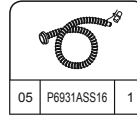
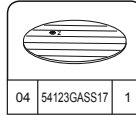
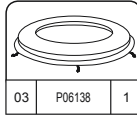
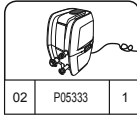
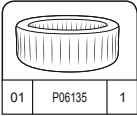

# BALI AIRJET S100104 (60010)

— 71" x 26" / 1.80 m x 66 cm



2 - 4



2-3°F/h  
1-1.5°C/h



320 gal/h  
1,211 L/h



0.034-0.055Bar  
0.5-0.8PSI



177 gal  
669 L



1,534 Lb  
696 kg

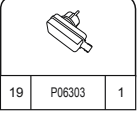
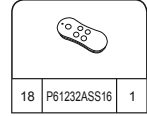
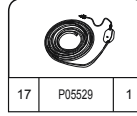
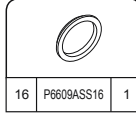
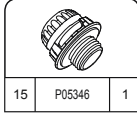
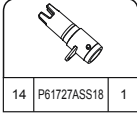
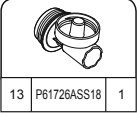
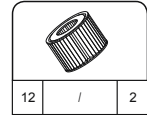
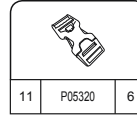
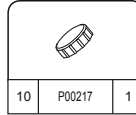
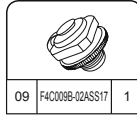
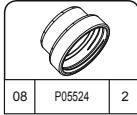
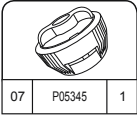
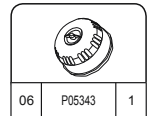
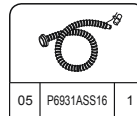
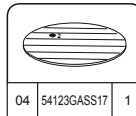
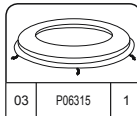
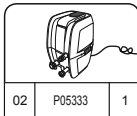
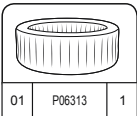

## IBIZA AIRJET S100104 (60016)

— 71" x 71" x 26" / 1.80 m x 1.80 m x 66 cm



4 - 6



2-3°F/h  
1-1.5°C/h



320 gal/h  
1,211 L/h



0.034-0.055Bar  
0.5-0.8PSI



205 gal  
778 L



1,779 Lb  
807 kg

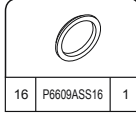
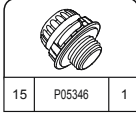
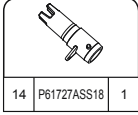
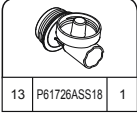
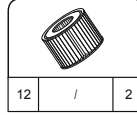
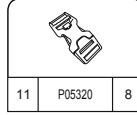
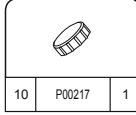
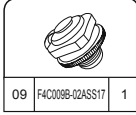
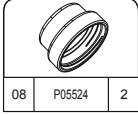
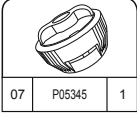
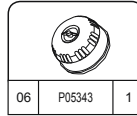
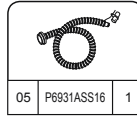
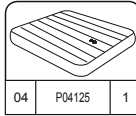
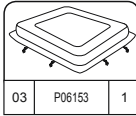
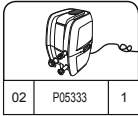
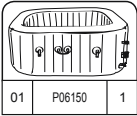

## PALM SPRINGS AIRJET S100104 (60018)

— 77" x 28" / 1.96 m x 71 cm



4 - 6



2-3°F/h  
1-1.5°C/h



320 gal/h  
1,211 L/h



0.08Bar  
1.2PSI



242 gal  
916 L



2,103 Lb  
954 kg

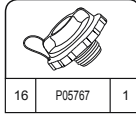
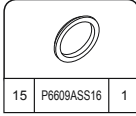
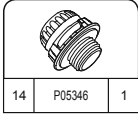
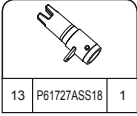
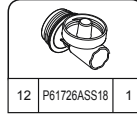
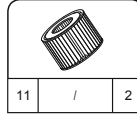
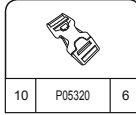
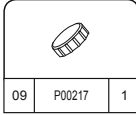
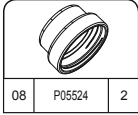
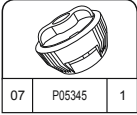
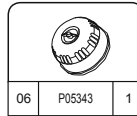
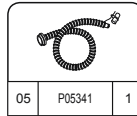
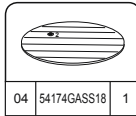
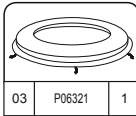
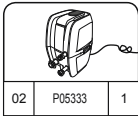
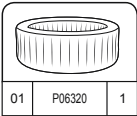

## HONOLULU AIRJET S100104 (60020)

— 77" x 28" / 1.96 m x 71 cm



4 - 6



2-3°F/h  
1-1.5°C/h



320 gal/h  
1,211 L/h



0.08Bar  
1.2PSI



242 gal  
916 L



2,103 Lb  
954 kg

	01	P05191	1		02	P05333	1		03	P05195	1		04	54174GASS18	1		05	P05341	1		06	P05343	1
	07	P05345	1		08	P05524	2		09	P00217	1		10	P05320	6		11	/	2		12	P61726ASS18	1
	13	P61727ASS18	1		14	P05346	1		15	P6609ASS16	1		16	P05767	1								

## HAWAII AIRJET S100104 (60022)

— 71" x 71" x 28" / 1.80 m x 1.80 m x 71 cm



4 - 6



2-3°F/h  
1-1.5°C/h



320 gal/h  
1,211 L/h



0.08Bar  
1.2PSI



222 gal  
840 L



1,938 Lb  
879 kg

	01	P05185	1		02	P05333	1		03	P05189	1		04	P04125	1		05	P05341	1		06	P05343	1
	07	P05345	1		08	P05524	2		09	P00217	1		10	P05320	8		11	/	2		12	P61726ASS18	1
	13	P61727ASS18	1		14	P05346	1		15	P6609ASS16	1		16	P05767	1								

## ST. MORITZ AIRJET S100104 (60024)

— 85" x 28" / 2.16 m x 71 cm



5 - 7



1-2°F/h  
0.5-1°C/h



320 gal/h  
1,211 L/h











0.08Bar  
1.2PSI

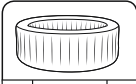

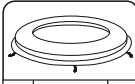
314 gal  
1190 L

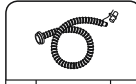

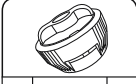
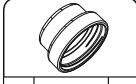
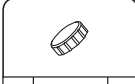
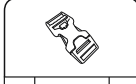
2,668 Lb  
1210 kg

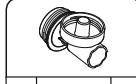
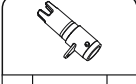
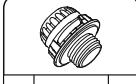
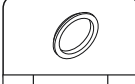
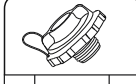
 01 P05197 1	 02 P05333 1	 03 P05201 1	 04 54175GASS18 1	 05 P05341 1	 06 P05343 1
 07 P05345 1	 08 P05524 2	 09 P00217 1	 10 P05320 8	 11 / 2	 12 P61726ASS18 1
 13 P61727ASS18 1	 14 P05346 1	 15 P6609ASS16 1	 16 P05767 1		

## HELSINKI AIRJET S100104 (60026)

— 71" x 26" / 1.80 m x 66 cm



5 - 7



1-2°F/h  
0.5-1°C/h



320 gal/h  
1,211 L/h











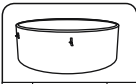
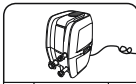
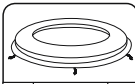

0.48-0.69Bar  
7-10PSI

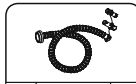

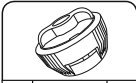
297 gal  
1123 L

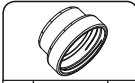
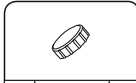
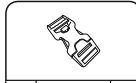

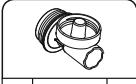
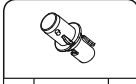

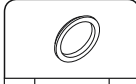
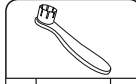



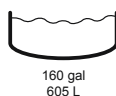

2,548 Lb  
1155 kg

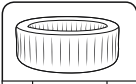
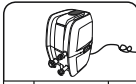
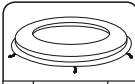
 01 P05203 1	 02 P05333 1	 03 P05207 1	 04 P04122 1	 05 P05482 1	 06 P05343 1
 07 P05345 1	 08 P06327 1	 09 P05524 2	 10 P00217 1	 11 P05320 6	 12 / 2
 13 P61726ASS18 1	 14 P05344 1	 15 P05346 1	 16 P6609ASS16 1	 17 / 1	

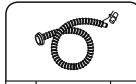
## ST.LUCIA AIRJET S100104 (60038)

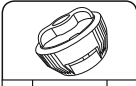
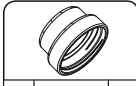
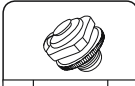
— 67" x 26" / 1.70 m x 66 cm

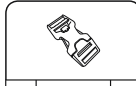

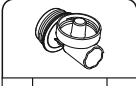
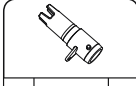
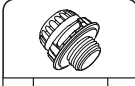
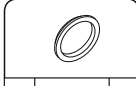







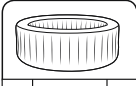
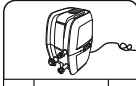
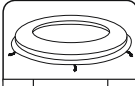

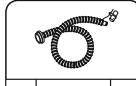
 01 P06158 1	 02 P05333 1	 03 P06164 1	 04 P05091 1	 05 P6931ASS16 1	 06 P05343 1
 07 P05345 1	 08 P05524 2	 09 F4C009B-02ASS17 1	 10 P00217 1	 11 P05320 5	 12 / 2
 13 P61726ASS18 1	 14 P61727ASS18 1	 15 P05346 1	 16 P6609ASS16 1		

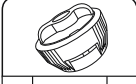
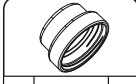
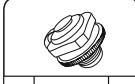
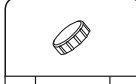
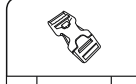
## HOLLYWOOD AIRJET S100104 (60060)

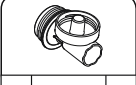
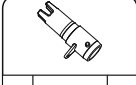
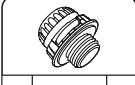
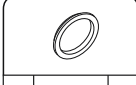
— 77" x 26" / 1.96 m x 66 cm

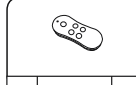
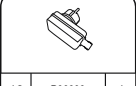

 01 P06199 1	 02 P05333 1	 03 P06202 1	 04 54112GASS15 1	 05 P6931ASS16 1	 06 P05343 1
 07 P05345 1	 08 P05524 2	 09 F4C009B-02ASS17 1	 10 P00217 1	 11 P05320 6	 12 / 2
 13 P61726ASS18 1	 14 P61727ASS18 1	 15 P05346 1	 16 P6609ASS16 1	 17 P05513 1	 18 P61232ASS16 1
 19 P06303 1	 20 P06280 4				

# ARUBA AIRJET S100104 (60062)

— 67" x 26" / 1.70 m x 66 cm



2 - 3



2-3°F/h  
1-1.5°C/h



320 gal/h  
1,211 L/h













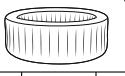

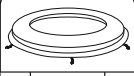

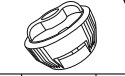

0.034-0.055Bar  
0.5-0.8PSI



160 gal  
605 L



1,389 Lb  
630 kg

 01 P06161 1	 02 P05333 1	 03 P06166 1	 04 P05091 1	 05 P6931ASS16 1	 06 P05343 1
 07 P05345 1	 08 P05524 2	 09 F4C009B-02ASS17 1	 10 P00217 1	 11 P05320 5	 12 / 2
 13 P61726ASS18 1	 14 P61727ASS18 1	 15 P05346 1	 16 P6609ASS16 1		

# FIJI AIRJET S100104 (60086)

— 71" x 26" / 1.80 m x 66 cm



2 - 4



2-3°F/h  
1-1.5°C/h



320 gal/h  
1,211 L/h













0.034-0.055Bar  
0.5-0.8PSI

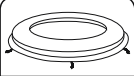
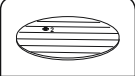

177 gal  
669 L

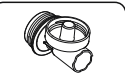
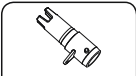
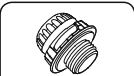
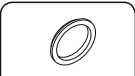

1,534 Lb  
696 kg

 01 P06282 1	 02 P05333 1	 03 P06285 1	 04 54123GASS17 1	 05 P6931ASS16 1	 06 P05343 1
 07 P05345 1	 08 P05524 2	 09 F4C009B-02ASS17 1	 10 P00217 1	 11 P05320 6	 12 / 2
 13 P61726ASS18 1	 14 P61727ASS18 1	 15 P05346 1	 16 P6609ASS16 1		

# INSTALACIÓN



## INSTRUCCIONES PARA USO EN INVIERNO

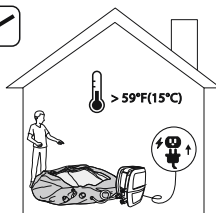
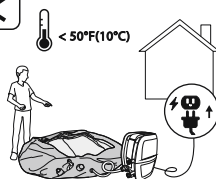

Es importante seguir estas instrucciones si instala el spa durante el invierno. Esto evitará daños al material de PVC y alargará la vida del producto significativamente.

- Si la temperatura ambiente es inferior a 50°F (10°C), sugerimos mantener el embalaje en el interior, donde la temperatura sea superior a 59°F (15°C) durante al menos 2 horas antes de inflarlo. Esto hará que el revestimiento del spa sea más flexible y más fácil de instalar.
  - Abra el embalaje en la misma habitación donde la temperatura sea superior a 59°F (15°C) e infle el spa con el calentador.
  - Coloque el revestimiento del spa en el exterior en la posición deseada, conecte el calentador y llénelo de agua.
- Importante:** la temperatura del agua utilizada para llenar el spa debe ser superior a 42,8°F (6°C); de lo contrario, cuando empiece a funcionar con el calentador, aparecerá la alarma E03.

**Importante:** si el sistema Freeze Shield™ no funciona, aparecerán alarmas en el spa. Asegúrese de verificar el estado de su spa si la temperatura exterior es inferior a 42,8°F (6°C). En caso de una ausencia prolongada en el hogar cuando existe el riesgo de que las temperaturas caigan por debajo de los 42,8°F (6°C), sugerimos encarecidamente desmontar el spa y almacenarlo como se indica. Cuando monte el spa, la función de calentamiento automático se activará. En estas condiciones, el spa se puede usar cuando la temperatura sea inferior a 42,8°F (6°C).

**NOTA:** El manómetro de aire de la bomba manual solo muestra la presión de aire cuando esta es superior a 5 psi, lo cual es normal. Cuando la presión de aire en el producto es inferior a 5 psi, el manómetro de presión de aire no mostrará un valor (solo para spas tipo drop stitch).

1

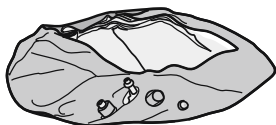

2

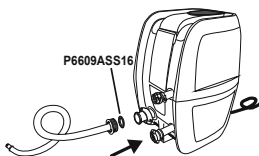

3

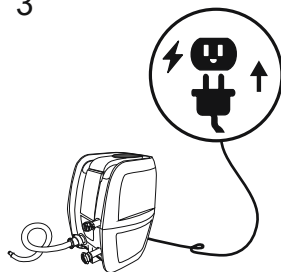

4

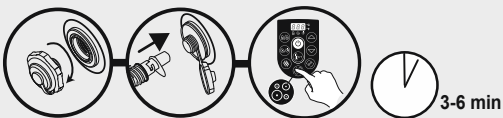
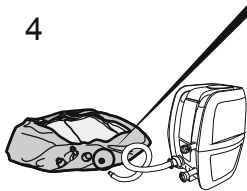

HELSINKI

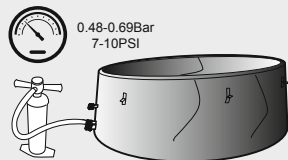

HOLLYWOOD BALI

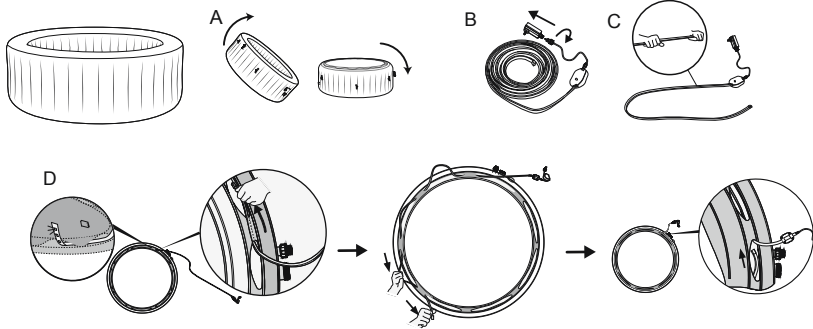

5

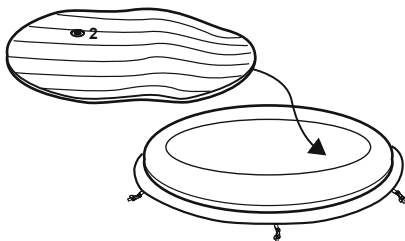

6

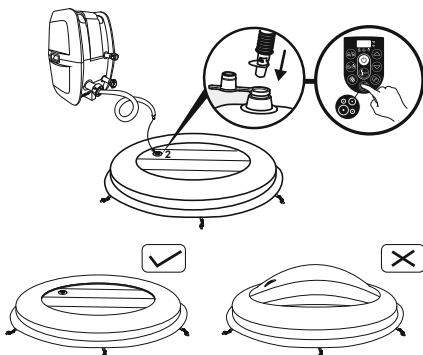



7

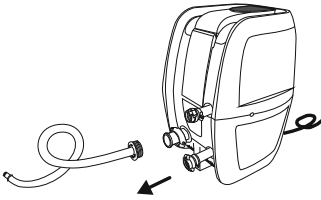

8

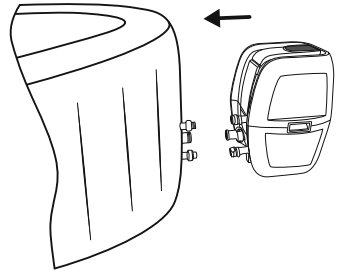

9

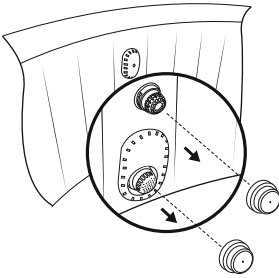

10

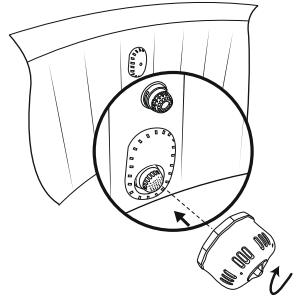

11.1



11.2 HOLLYWOOD

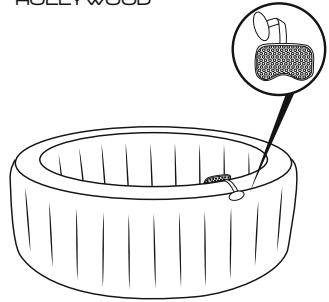

### TEST GFCI

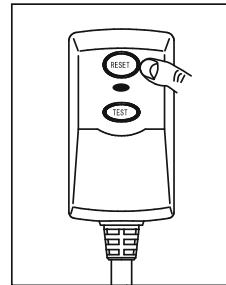
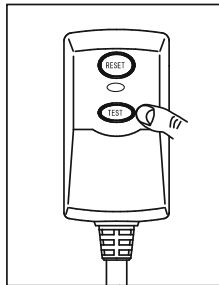
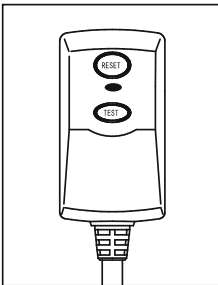

Durante el inflado, notará que sale aire del área donde la manguera de aire se conecta a la bomba; esto es normal por los requisitos técnicos.

**Importante:** no cubra los agujeros en la base de la manguera de inflado, ya que esto inflará demasiado el revestimiento y dañará la estructura.

No utilice un compresor de aire para inflar la piscina.

No arrastre la piscina por terrenos irregulares, ya que esto podría dañar el forro.

Tiempo de inflado solo como referencia.

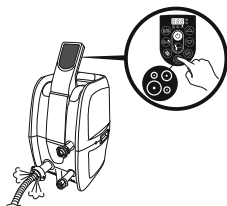

### Comprobación de la válvula de aire (para spa con válvula de inflado/desinflado rápido)

Revise siempre la válvula de aire minuciosamente antes del inflado para comprobar que no haya una fuga de aire. Si la válvula de aire está suelta, utilice la llave proporcionada para sujetarla siguiendo estos pasos:

con una mano, sujete la parte trasera de la válvula de aire desde el lado interior de la pared del spa y gire la llave en sentido horario.

#### NOTE:

1.No la apriete demasiado.

2.No ajuste el conector de la válvula de aire cuando el spa esté en uso.

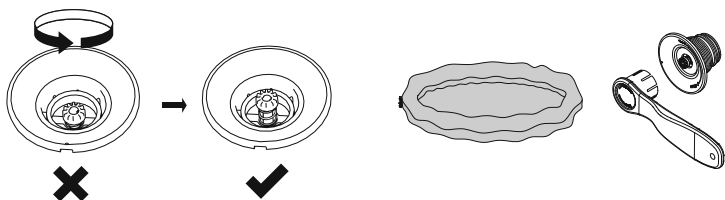

# USO DEL SPA

La hipertermia es un fenómeno que se produce cuando la temperatura interna del cuerpo supera en varios grados la temperatura corporal normal 98.6°F(37°C). Los síntomas de la hipertermia incluyen un incremento en la temperatura interna del cuerpo, mareo, letargo, somnolencia y desvanecimiento. Los efectos de la hipertermia incluyen incapacidad para percibir el calor; incapacidad para reconocer la necesidad de salir del jacuzzi o spa; inconsciencia respecto a un peligro inminente; daño fetal en mujeres embarazadas; incapacidad física para salir del spa o jacuzzi; y pérdida de conocimiento resultante con peligro de ahogamiento.

**ADVERTENCIA:** el uso de alcohol, drogas o medicamentos puede aumentar considerablemente el riesgo de hipertermia mortal.

**ADVERTENCIA:** LA TEMPERATURA DEL AGUA SUPERIOR A LOS 100°F (38°C) PUEDE SER DAÑINA A SU SALUD.

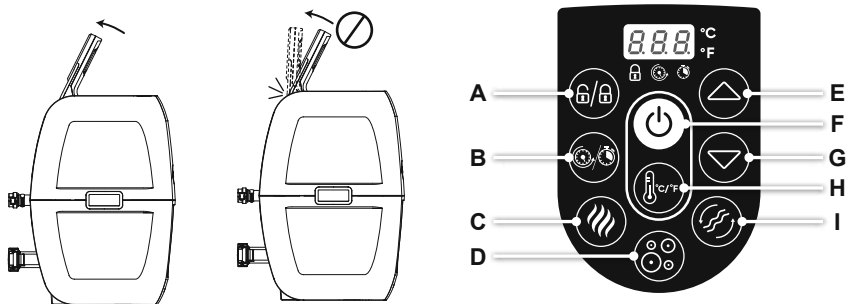

**A. BOTÓN DE BLOQUEO/DESBLOQUEO:** la bomba tiene un bloqueo automático de 5 minutos; la luz se encenderá. Para bloquear o desbloquear la bomba, presione el botón de bloqueo/desbloqueo durante 3 segundos.



**B. BOTÓN DEL TEMPORIZADOR DE AHORRO DE ENERGÍA:** diseñado para ayudar a evitar el desperdicio de energía con la configuración de tiempo y duración del ciclo de calentamiento del spa. De esta forma, podrá disfrutar de su spa en el momento que desee, sin tener que dejar el calentador siempre encendido.

**PASO 1:** ajustar la duración del calentamiento

1. Pulse el botón de la unidad; el botón LED empezará a parpadear.
2. Pulse el botón o para ajustar la duración del calentamiento (de 1 a 999 horas).
3. Vuelva a pulsar el botón para confirmar la duración del calentamiento.

**PASO 2:** establecer en cuántas horas A PARTIR DE AHORA se activará el calentador

1. Después de ajustar la duración del calentamiento, el botón LED empezará a parpadear.
2. Pulse el botón o para ajustar en cuántas horas tendrá lugar la activación (de 0 a 999 horas).
3. Vuelva a pulsar el botón o sencillamente no toque nada durante 10 segundos para confirmar el ajuste. El botón LED permanecerá encendido y comenzará la cuenta atrás para la activación del calentador. Para modificar la configuración del temporizador: pulse el botón y use los botones o para ajustarlo. Cancelar la configuración: pulse el botón durante 2 segundos.

**NOTA:** tras establecer la configuración, la pantalla muestra de forma alterna la temperatura y el tiempo actuales.

**NOTA:** el ajuste del temporizador (número de horas con el calentador ENCENDIDO) se puede establecer de 1 a 999 horas; el ajuste del tiempo de reserva (en cuántas horas A PARTIR DE AHORA el calentador empezará a funcionar) se puede configurar de 0 a 999 horas. Si el temporizador está configurado a 0 horas, el sistema de calefacción se activará de inmediato.

Tenga en cuenta que el temporizador funciona una vez por uso: el usuario establece la duración del ciclo de calefacción y en cuántas horas a partir de ahora empezará el ciclo de calentamiento. El temporizador NO se repite hasta que se reinicia.



**C. BOTÓN DE CALEFACCIÓN:** utilice este botón para activar el sistema de calefacción. Cuando la luz situada sobre el botón de calentamiento se ponga roja, el sistema de calefacción se habrá activado. Cuando la luz se ponga verde, el agua estará a la temperatura establecida y el sistema de calefacción se pondrá en reposo.

**NOTA:** si el sistema de calefacción está activado, el sistema de filtración se iniciará automáticamente.

**NOTA:** después de apagar el sistema de calefacción, el sistema de filtración seguirá funcionando.

**NOTA:** si el calentador del spa está encendido cuando la temperatura del agua es inferior a 42,8°F (6°C), el sistema de calefacción calentará el agua hasta 50°F (10°C) automáticamente.



**D. BOTÓN DEL SISTEMA DE MASAJE:** use este botón para activar el sistema de masaje, que tiene una función de apagado automático de 30 minutos. La luz situada sobre el botón del sistema de masaje se pone roja cuando está activado. **IMPORTANTE:** no ejecute el sistema de masaje cuando la cubierta esté colocada. El aire puede acumularse dentro del spa y causar daños irreparables a la cubierta y lesiones corporales.

**NOTA:** la calefacción y el sistema de masaje funcionan a la vez para crear una experiencia de masaje cálido.



**E/G. BOTONES DE AJUSTE DE LA TEMPERATURA:** al pulsar los botones para aumentar o reducir la temperatura, el LED parpadeará.

Cuando esté parpadeando, puede ajustar la temperatura deseada. Si mantiene pulsados estos botones, los valores aumentarán o disminuirán rápidamente.

El nuevo ajuste de temperatura permanecerá en la pantalla LED durante 3 segundos para confirmar el nuevo valor.

**NOTA:** la temperatura predeterminada es de 95°F (35°C).

**NOTA:** el ajuste de temperatura varía de 68°F (20°C) a 104°F (40°C).



**F. BOTÓN ON/OFF:** presione este botón durante 2 segundos para activar el panel de control; la luz se vuelve verde. Pulse este botón durante 2 segundos para desactivar todas las funciones activadas actualmente.



**H. CONMUTACIÓN CELSIUS/FAHRENHEIT:** la temperatura se puede mostrar en grados Fahrenheit o Celsius.



**I. BOTÓN DEL FILTRO DE AGUA:** este botón enciende y apaga la bomba del filtro. La luz situada sobre el botón del filtro de agua se pone roja cuando está activado.



**LED DEL TEMPORIZADOR DE AHORRO DE ENERGÍA:**

este LED indica cuando está configurando la duración de la calefacción. La luz estará encendida cuando la función de calefacción empiece a funcionar.

Este LED indica cuando está estableciendo en cuántas horas A PARTIR DE AHORA se activará el calentador. Cuando la luz está encendida, la función del temporizador de ahorro de energía está activada.



**NOTA:** el consumo del CALENTADOR DE AGUA puede cambiar en las siguientes condiciones:

- cuando la temperatura exterior es inferior a 59°F (15°C);
- si la cubierta no está colocada cuando la función de calefacción está activada.

**NOTA:** para mostrar la temperatura actual del agua, ejecute el sistema de filtro durante al menos un minuto.

La temperatura del agua probada por un termómetro externo puede variar en relación con la temperatura que aparece en el panel del spa hasta aproximadamente 35,6°F (2°C).

## INSTRUCCIONES DE USO EN INVIERNO



- Puede mantener el spa encendido durante el invierno cuando la temperatura sea inferior a 42,8°F (6°C). El sistema Freeze Shield™ mantiene automáticamente la temperatura del agua entre 42,8°F (6°C) y 50°F (10°C), y evita que el agua se congele.

**Importante:** si la temperatura exterior es inferior a 6°C, el calentador del spa debe estar siempre encendido. En este modo, el sistema Freeze Shield™ puede mantener la temperatura interna entre 42,8°F (6°C) y 50°F (10°C) para evitar daños, como la congelación del agua en las tuberías o en el sistema de circulación.

**Importante:** si el sistema Freeze Shield™ no funciona, aparecerán alarmas en el spa.

Asegúrese de verificar el estado de su spa si la temperatura exterior es inferior a 42,8°F (6°C) En caso de una ausencia prolongada en el hogar cuando existe el riesgo de que las temperaturas caigan por debajo de los 42,8°F (6°C), sugerimos encarecidamente desmontar el spa y almacenarlo como se indica.

- Cualquier daño provocado por el uso del spa en estas condiciones es responsabilidad del cliente. No utilice el spa cuando la temperatura ambiente alcance los 14°F (-10°C).

## IMPORTANTE

Para alcanzar los 104°F (40°C), la duración de calentamiento requerida se basa en la temperatura inicial del agua y la temperatura ambiente, los siguientes datos son puramente de referencia. para mostrar la temperatura actual del agua, ejecute el sistema de filtro durante al menos un minuto.

Temperatura ambiente	Temperatura del agua	Temperatura establecida	Duración del calentamiento
50°F(10°C)	50°F(10°C)	104°F(40°C)	32 h
59°F(15°C)	59°F(15°C)	104°F(40°C)	26 h
68°F(20°C)	68°F(20°C)	104°F(40°C)	20 h
77°F(25°C)	77°F(25°C)	104°F(40°C)	14 h
86°F(30°C)	86°F(30°C)	104°F(40°C)	9 h

- Asegúrese de cubrir el spa con la cubierta del spa siempre que se active la función de calefacción. Si deja el spa descubierto, aumentará la duración de calentamiento requerida.
- Cuando el spa esté montado y con agua, no apague el calentador si la temperatura es inferior a 42,8°F (6°C).

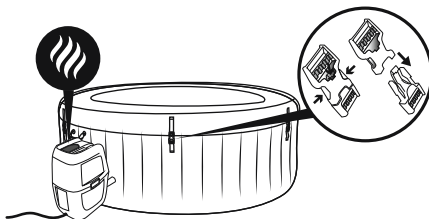

Tasa de potencia	Fuelle masajeador turbo	Resistencia térmica	Bomba de agua
110-120 V CA, 60Hz, monofásico 12A a 20°C	6,5A	11,3 A a 20°C	0.7A

# MANTENIMIENTO

**PRECAUCIÓN:** debe asegurarse de que la bomba está desenchufada antes de empezar el mantenimiento del spa para evitar el riesgos de lesiones o la muerte.

**Añadir aire:** su spa requerirá que se añada aire adicional de vez en cuando. Los cambios de temperatura del día a la noche cambiarán la presión del spa y pueden causar un cierto nivel de desinflado. Siga las instrucciones de montaje e inflelo a la presión precisa necesaria.

Cuando necesite usar la bomba para el inflado, bloquee las mangueras para evitar que el agua se escape; después desconecte la bomba y atornille la tapa (P00217) para evitar que salga agua del tubo de aire.

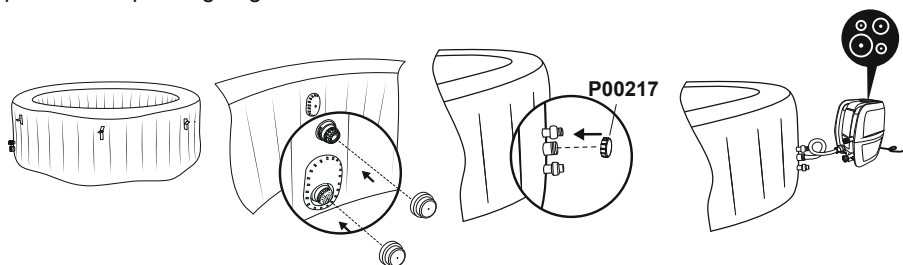

## Mantenimiento de la cubierta

La cubierta debe limpiarse por dentro y por fuera periódicamente usando una solución adecuada que incluya una desinfección adecuada (por ejemplo, 10 mg/l de cloro libre).

## Mantenimiento del cartucho del filtro

Para asegurarse de que el agua de su spa permanezca limpia, revise y limpie los cartuchos del filtro todos los días, siguiendo los pasos indicados a continuación.

**NOTA:** recomendamos cambiar los cartuchos del filtro cada semana, o sustituirlos si siguen sucios y descoloridos.

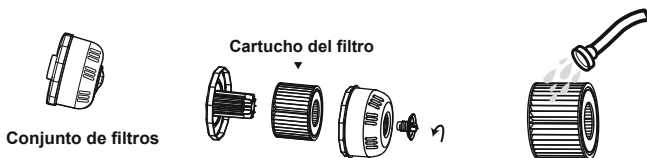

## Mantenimiento del agua

Muchos contaminantes del agua se depositan en las superficies debajo de la línea de agua. Estos pueden provocar el crecimiento de bacterias, algas u hongos. Se recomienda limpiar los spas con la frecuencia necesaria. Transcurrido un tiempo, pueden aparecer manchas persistentes o biopelículas en las superficies accesibles debajo de la línea de agua, o pueden darse altas concentraciones de sales o subproductos de reacción no deseados. Dependiendo de las condiciones higiénicas, la limpieza, la visibilidad, el olor, los residuos y las manchas, se recomienda cambiar el agua completamente y limpiar/desinfectar el spa. Al vaciar el spa, se deben seguir las normas y las instrucciones para drenar el agua. Es necesario mantener el agua del spa limpia y químicamente equilibrada. La simple limpieza del cartucho del filtro no es suficiente para realizar un mantenimiento adecuado; le recomendamos que utilice productos químicos para piscinas para mantener una química del agua adecuada y las tabletas de cloro o bromo (no use gránulos) con el dispensador de

productos químicos. La calidad del agua estará directamente relacionada con la frecuencia de uso, la cantidad de usuarios y el mantenimiento general del spa. El agua debe cambiarse cada 3 días si no se aplica un tratamiento químico. Es altamente recomendable usar agua del grifo para el llenado del spa para minimizar la influencia de contenido no deseado, como minerales. Las zonas para andar descalzo y las áreas de descanso también deben limpiarse. El agua de limpieza no puede entrar en el spa o en el ciclo de agua del mismo. La suciedad y los agentes de limpieza deben enjuagarse con cuidado para que se drenen en los alrededores del spa.

**Nota:** le recomendamos que se duche antes de usar el SaluSpa, ya que los productos cosméticos, las lociones y otros residuos de la piel pueden degradar rápidamente la calidad del agua. Para utilizar el dispensador de productos químicos, siga las instrucciones detalladas a continuación.

### Uso de tabletas químicas (no incluidas):

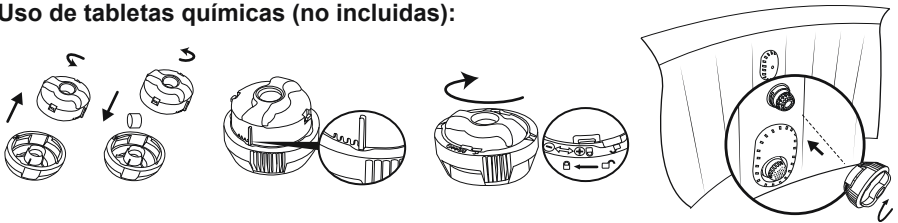

**Importante:** no use tabletas granuladas ni la arroje directamente al agua; los químicos se depositarán en el fondo y dañarán el material y decolorarán el PVC.

### Uso de líquido químico (no incluido):

**Importante:** añada líquido químico en el centro de la piscina en pequeñas dosis y evite el contacto directo del químico con la superficie del spa, ya que el contacto directo de los químicos con el material del spa dañará el material y decolorará la superficie.

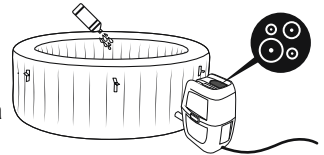

**NOTA:** retire el dispensador de productos químicos del spa cuando el spa esté en uso.

**IMPORTANTE:** después de realizar el mantenimiento químico y antes de usar el spa, utilice un kit de prueba (no incluido) para probar la química del agua. Recomendamos mantener las condiciones del agua como se muestra en la siguiente tabla.

pH	Alcalinidad total	Cloro libre
7.4-7.6	80-120ppm	2-4ppm

**NOTA:** la garantía no cubre los daños resultantes de desequilibrios químicos. Los productos químicos para piscinas son potencialmente tóxicos y deben manejarse con cuidado. Existen riesgos graves para la salud debido a los vapores químicos y al etiquetado y almacenamiento incorrectos de los contenedores de productos químicos. Consulte a su distribuidor local de suministros para piscinas para obtener más información sobre el mantenimiento químico. Preste mucha atención a las instrucciones del fabricante del producto químico. La garantía no cubre los daños causados por el uso indebido de productos químicos y la mala gestión del agua del spa.

**Importante:** el uso excesivo de productos químicos decolorará el estampado y todos los puntos del material del spa y, en el peor de los casos, dañará la estructura del revestimiento del spa.

# DESMONTAJE Y ALMACENAMIENTO

## DRENAJE DEL SPA

1.

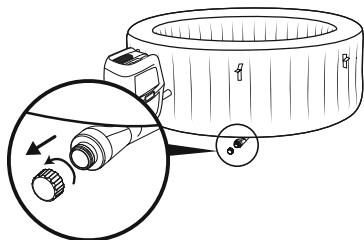

2.

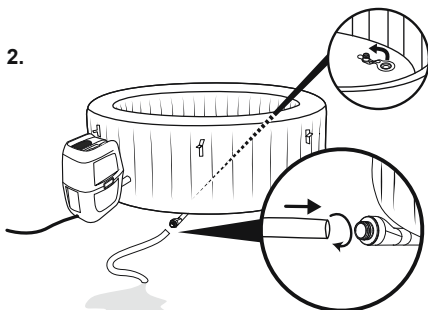

3. **NOTA:** seque la piscina del spa.



4.

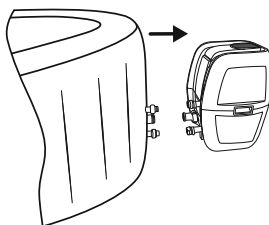

5.

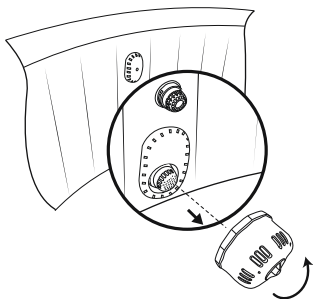

6.

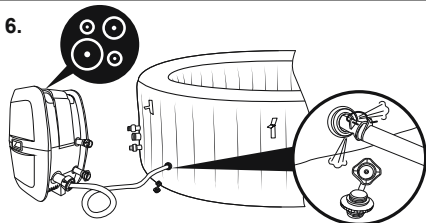

Para los spas Bali y Hollywood:  
Puede encontrar vapor dentro de la cámara de aire y puede aparecer moho después del almacenamiento si hay agua en el interior. Desenrosque la válvula y use el tubo para soplar en la cámara de aire hasta que seque todo el vapor del interior. Esta operación puede tardar de 2 a 5 horas

## Solo para el spa Drop Stitch

1.



2.

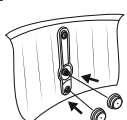

3.

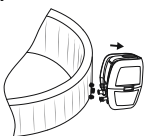

4.

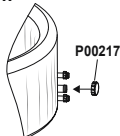

5.

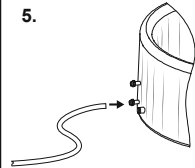

6.

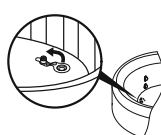

**NOTA:** levante el spa cuando solo quede un poco de agua. Los daños en los mangos no están cubiertos.

8. **NOTA:**

seque la piscina del spa.





Asegúrese de que el spa y la bomba estén completamente secos. Esto es esencial para prolongar la vida útil del spa. Recomendamos utilizar la bomba para secar el spa, la bomba y las tuberías. Retire los conjuntos de filtros y deseche los cartuchos de filtro usados. Vuelva a colocar los dos tapones de cierre en las válvulas de entrada y salida del spa. Es recomendable guardar el spa en su paquete original en un lugar seco y cálido (por encima de los 15°C, esto es, 59°F).

## LIMPIEZA DEL SPA

Los residuos de detergente y los sólidos disueltos de los trajes de baño y los productos químicos pueden acumularse en las paredes del spa. Use agua y jabón para limpiar las paredes y enjuáguelas bien.

**NOTA:** NO utilice cepillos duros ni productos de limpieza abrasivos.

## DESINFLADO

El spa está equipado con una función de desinflado para eliminar todo el aire del interior de la cámara y facilitar su empaquetamiento y almacenamiento.

Válvula de tornillo 

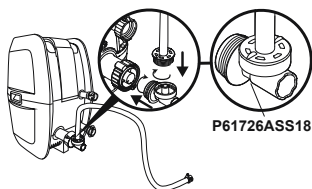

P61727ASS18

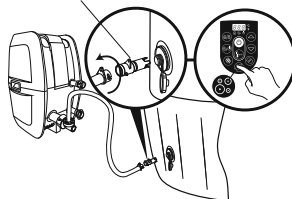

Válvula de inflado/desinflado rápido 

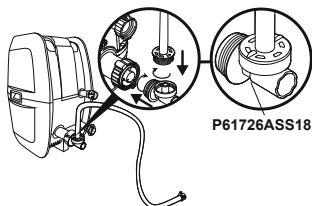

P05344

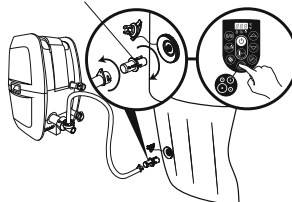

## REPARACIÓN

### Para la pieza de PVC.

Si el hidromasaje presenta alguna rotura o algún pinchazo, use el parche de reparación adhesivosumergible entregado.

1. Limpie la zona a reparar.
2. Retire el parche con cuidado de su soporte.
3. Presione el parche sobre la zona a reparar.
4. Espere 30 segundos antes de hinchar.

### Para material PVC TriTech.

Si el hidromasaje presenta alguna rotura o algún pinchazo, use el parche de reparación de PVC incluido y cola (no incluida) siguiendo los pasos siguientes:







1. Limpie y seque la zona que desea reparar.
2. Recorte el parche de PVC incluida para obtener el tamaño adecuado.
3. Utilice cola (no incluida) para recubrir un lado del parche recortado. Compruebe que la cola esté distribuida de forma homogénea.
4. Espere 30 segundos y aplique el parche encolado sobre la zona dañada.
5. Elimine cualquier burbuja de aire que pudiera haber quedado atrapada debajo del parche y presione con firmeza durante dos minutos.
6. El producto ya vuelve a estar listo para su uso. Repita este proceso si apareciesen nuevas fugas.
7. Espere 30 minutos antes de volver a inflar.

# RESOLUCIÓN DE PROBLEMAS

Bestway se esfuerza por ofrecer los hidromasajes que causen menos problemas del mercado. Si experimenta cualquier tipo de problema, no dude en ponerse en contacto con Bestway o con su vendedor autorizado. Aquí encontrará algunos consejos útiles para ayudarle a diagnosticar y corregir algunas causas de problemas comunes.

Problema	Causas probables	Soluciones
La bomba no funciona	<ul style="list-style-type: none"> <li>- Fallo eléctrico</li> <li>- GFCI averiado</li> </ul>	<ul style="list-style-type: none"> <li>- Compruebe la fuente de alimentación</li> <li>- Para recibir asistencia, visite la sección de soporte de nuestro sitio web: <a href="http://www.bestwaycorp.com">www.bestwaycorp.com</a>.</li> </ul>
La bomba no calienta correctamente	<ul style="list-style-type: none"> <li>- Temperatura ajustada demasiado baja</li> <li>- Cartucho del filtro sucio</li> <li>- Desconexión del disyuntor térmico</li> <li>- El hidromasaje no está cubierto</li> <li>- El sistema de calefacción falló</li> </ul>	<ul style="list-style-type: none"> <li>- Ajuste a una temperatura más alta, consulte la sección sobre el funcionamiento de la bomba</li> <li>- Limpie/sustituya el cartucho de filtrado, consulte la sección sobre limpieza y sustitución del cartucho de filtrado</li> <li>- Agregue agua hasta el nivel especificado</li> <li>- Desenchufe la bomba y coloque la toma en un lugar seco y fresco. Vuelva a encenderla únicamente cuando la temperatura del agua sea igual o inferior a 35°C o inferior</li> <li>- Cubra el hidromasaje con la cubierta</li> <li>- Para recibir asistencia, visite la sección de soporte de nuestro sitio web: <a href="http://www.bestwaycorp.com">www.bestwaycorp.com</a>.</li> </ul>
El sistema massage no funciona	<ul style="list-style-type: none"> <li>- La bomba de aire se ha sobrecalentado</li> <li>- El sistema de masaje del Spa se detiene automáticamente</li> <li>- La bomba de aire está rota</li> </ul>	<ul style="list-style-type: none"> <li>- Desenchufe la bomba y espere dos horas hasta que la bomba se enfríe</li> <li>- Introduzca el enchufe y pulse el botón massage System</li> <li>- Pulse el botón massage System para reactivar el sistema</li> <li>- Para recibir asistencia, visite la sección de soporte de nuestro sitio web: <a href="http://www.bestwaycorp.com">www.bestwaycorp.com</a>.</li> </ul>
Los adaptadores de bomba no están a nivel respecto a los adaptadores de hidromasaje	<ul style="list-style-type: none"> <li>- Una característica del PVC es que cambia de forma, algo perfectamente normal</li> </ul>	<ul style="list-style-type: none"> <li>- Puede elevar la bomba con un trozo de madera o cualquier otro tipo de material aislante para poner a nivel los adaptadores de la bomba respecto a los adaptadores del hidromasaje</li> </ul>
Fuite au niveau de la piscine spa	<ul style="list-style-type: none"> <li>- El hidromasaje presenta alguna rotura o algún pinchazo</li> <li>- La válvula de aire está suelta</li> </ul>	<ul style="list-style-type: none"> <li>- Use el parche de reparación incluido</li> <li>- Cubra la válvula de aire con agua jabonosa para comprobar si está dejando escapar el aire. Si así fuera, utilice la llave proporcionada para ajustar la válvula de aire siguiendo estos pasos:             <ol style="list-style-type: none"> <li>1. Desinfele el hidromasaje</li> <li>2. Sostenga con una mano la parte posterior de la válvula de aire del interior de la pared del hidromasaje y gire la tuerca en sentido horario</li> </ol> </li> </ul>
Agua no limpia	<ul style="list-style-type: none"> <li>- Tiempo de filtrado insuficiente</li> <li>- Cartucho de filtro sucio</li> <li>- Mantenimiento del agua incorrecto</li> </ul>	<ul style="list-style-type: none"> <li>- Aumente el tiempo de filtrado</li> <li>- Limpie/reemplace el cartucho de filtro (consulte la sección de Limpieza y reparación del cartucho de filtro)</li> <li>- Consulte las instrucciones del fabricante de los productos químicos</li> </ul>
El panel de control no funciona	<ul style="list-style-type: none"> <li>- El panel de control tiene un bloqueo automático, que se activa al cabo de 5 minutos de inactividad. La pantalla LED tiene un icono:  si el icono de bloqueo está resaltado, el panel de control está bloqueado.</li> <li>- El panel de control no está activo.</li> </ul>	<ul style="list-style-type: none"> <li>- Para desbloquear el panel de control, pulse el botón  durante 3 segundos. Si el panel de control no se desbloquea, reinicie la bomba: desenchufe y vuelva a enchufar la bomba.</li> <li>- Pulse el botón de encendido/apagado (on/off) durante 2 segundos.</li> <li>- Si el problema persiste, Para recibir asistencia, visite la sección de soporte de nuestro sitio web: <a href="http://www.bestwaycorp.com">www.bestwaycorp.com</a>.</li> </ul>
Error al realizar el test GFCI	Su spa está averiado	Para recibir asistencia, visite la sección de soporte de nuestro sitio web: <a href="http://www.bestwaycorp.com">www.bestwaycorp.com</a> .
¿Qué tipo de tratamientos químicos deberían utilizarse para el mantenimiento del agua?	Consulte con su proveedor local de tratamientos químicos para solicitar información al respecto. Siga atentamente las instrucciones del fabricante de los productos químicos.	
Hay fugas de agua en los adaptadores entre la bomba y el hidromasaje	<ul style="list-style-type: none"> <li>- Faltan las juntas dentro de los adaptadores de la bomba.</li> <li>- Las juntas no están en la posición correcta.</li> <li>- Las juntas están dañadas.</li> <li>- Los adaptadores no están correctamente apretados.</li> </ul>	<ul style="list-style-type: none"> <li>- Inserte los tapones de cierre en los puertos del spa para evitar que el agua se filtre y desconecte la bomba. Compruebe que las juntas estén correctamente colocadas.</li> <li>- Si las juntas no están correctamente colocadas, abra los engranajes y coloque las juntas en la posición correcta.</li> <li>- Si las juntas están dañadas, debe sustituirlas. Para recibir asistencia, visite la sección de soporte de nuestro sitio web: <a href="http://www.bestwaycorp.com">www.bestwaycorp.com</a>.</li> <li>- Si las juntas no están correctamente colocadas, los adaptadores no están correctamente apretados. Conecte la bomba al spa, apriete a mano los adaptadores y retire los tapones de cierre de los puertos del spa. Si hay fugas, apriete el adaptador hasta que desaparezcan.</li> </ul>

# CÓDIGOS DE ERROR

CAUSAS	MOTIVOS	SOLUCIONES
<p>Los sensores de caudal de agua funcionan sin presionar el botón de filtrado o calentamiento</p> 	<ol style="list-style-type: none"> <li>Los indicadores de los sensores de caudal de agua no bajaron y no se posicionaron correctamente</li> <li>Los sensores del caudal de agua están rotos</li> </ol>	<ol style="list-style-type: none"> <li>Desenchufe el aparato, golpee suavemente el lateral de la bomba y vuelva a enchufar.</li> <li>Para recibir asistencia, visite la sección de soporte de nuestro sitio web: <a href="http://www.bestwaycorp.com">www.bestwaycorp.com</a>.</li> </ol>
<p>Después del arranque o durante las funciones de filtrado y/o calentamiento, los sensores del caudal de agua no detectan el caudal de agua.</p> 	<ol style="list-style-type: none"> <li>Se olvidó de retirar los 3 tapones tope del interior de la piscina</li> <li>Los cartuchos de los filtros están sucios</li> <li>Active el sistema de filtrado o calentamiento y coloque la mano delante de la tubería de salida en el interior de la piscina para comprobar si sale agua                     <ol style="list-style-type: none"> <li>Si no sale agua, la bomba de agua está rota</li> <li>Sale agua pero se activa la alarma . Los sensores de caudal de</li> </ol> </li> <li>Bloqueo del filtro</li> <li>Tuberías dobladas o flujo de agua deficiente a través de las tuberías de plástico del revestimiento.</li> <li>Los filtros de residuos están bloqueados: el agua dura puede bloquear los filtros de residuos debido a la acumulación de calcio.</li> <li>Arandelas deterioradas Las arandelas del interior de los acoplamientos del spa pueden haberse desgastado o deteriorado.</li> </ol>	<ol style="list-style-type: none"> <li>Retire los 3 tapones tope antes de calentar, consulte el apartado Montaje del manual de instrucciones</li> <li>Retire el conjunto de filtrado del interior de la piscina y pulse el botón de filtrado o calentamiento. Si no aparece ningún mensaje de alarma, limpie o cambie los cartuchos de filtrado, instale el conjunto de filtrado en el interior de la piscina.</li> <li>Para recibir asistencia, visite la sección de soporte de nuestro sitio web: <a href="http://www.bestwaycorp.com">www.bestwaycorp.com</a>.</li> <li>Limpie el filtro y compruebe si hay daños. Sustitúyalo o reinstálelo según sea necesario. Para recibir asistencia, visite la sección de soporte de nuestro sitio web: <a href="http://www.bestwaycorp.com">www.bestwaycorp.com</a>.</li> <li>Revise la conexión del spa para comprobar si las tuberías están dobladas. Para recibir asistencia, visite la sección de soporte de nuestro sitio web: <a href="http://www.bestwaycorp.com">www.bestwaycorp.com</a>.</li> <li>Vacíe el spa y coloque una manguera de jardín dentro de las tuberías para limpiar los residuos. Realice la operación desde el exterior y el interior del spa para asegurarse de que se han eliminado todos los residuos. Use un cepillo de dientes para eliminar los restos persistentes. Para recibir asistencia, visite la sección de soporte de nuestro sitio web: <a href="http://www.bestwaycorp.com">www.bestwaycorp.com</a>.</li> <li>Compruebe si las arandelas del interior del acoplamiento presentan daños. Desenrosque los acoplamientos y retire la arandela para realizar una inspección adicional. Para recibir asistencia, visite la sección de soporte de nuestro sitio web: <a href="http://www.bestwaycorp.com">www.bestwaycorp.com</a>.</li> </ol>
<p>El termómetro de la bomba indica una temperatura inferior a 40°F (4°C)</p> 	<ol style="list-style-type: none"> <li>La temperatura del agua es inferior a 40°F (4°C)</li> <li>Si la temperatura del agua es superior a 44,6°F (7°C), el termómetro de la bomba está roto</li> </ol>	<ol style="list-style-type: none"> <li>El spa no ha sido diseñado para funcionar con temperaturas del agua por debajo de los 40°F (4°C). Desenchufe la bomba y vuelva a encenderla únicamente cuando la temperatura del agua alcance los 43°F (6°C)</li> <li>Para recibir asistencia, visite la sección de soporte de nuestro sitio web: <a href="http://www.bestwaycorp.com">www.bestwaycorp.com</a>.</li> </ol>
<p>El termómetro de la bomba indica una temperatura superior a 119°F (48°C)</p> 	<ol style="list-style-type: none"> <li>La temperatura del agua es superior a 119°F (48°C)</li> <li>La temperatura ambiente es superior a 104°F (40°C) o el spa está expuesto a la luz solar directa durante un período prolongado.</li> <li>Si la temperatura del agua es superior a 113°F (45°C), el termómetro de la bomba está roto</li> </ol>	<ol style="list-style-type: none"> <li>El spa no ha sido diseñado para funcionar con temperaturas del agua por encima de los 104°F (40°C). Desenchufe la bomba y vuelva a encenderla únicamente cuando la temperatura del agua sea igual o inferior a 100°F (38°C).</li> <li>Desconecte el enchufe, desconecte la bomba y drene el spa. Después de 15 minutos, vuelva a conectar la bomba, vuelva a conectar el enchufe y reinicie la función de calefacción. Si la alarma vuelve a aparecer, considere mover el spa a otro lugar sin luz solar directa.</li> <li>Para recibir asistencia, visite la sección de soporte de nuestro sitio web: <a href="http://www.bestwaycorp.com">www.bestwaycorp.com</a>.</li> </ol>
<p>Las conexiones del termómetro de la bomba presentan algún</p> 	<ol style="list-style-type: none"> <li>Los conectores del termómetro de la bomba no funcionan correctamente</li> <li>El termómetro de la bomba está roto</li> </ol>	<p>Para recibir asistencia, visite la sección de soporte de nuestro sitio web: <a href="http://www.bestwaycorp.com">www.bestwaycorp.com</a>.</p>
<p>Desconexión del disyuntor térmico.</p> 	<ol style="list-style-type: none"> <li>La temperatura ambiente es superior a 122°F (50°C) o la bomba se encuentra directamente bajo la luz solar.</li> <li>El disyuntor térmico está averiado.</li> </ol>	<ol style="list-style-type: none"> <li>Desenchufar la bomba y colocar el enchufe en un lugar seco y fresco. Vuelva a encender la bomba únicamente cuando la temperatura del agua alcance los 93,2 °F (34°C)</li> <li>Para recibir asistencia, visite la sección de soporte de nuestro sitio web: <a href="http://www.bestwaycorp.com">www.bestwaycorp.com</a>.</li> </ol>



# SALUSPA<sup>®</sup>

**Bestway**

# CONTEÚDO

---

INSTRUÇÕES IMPORTANTES DE SEGURANÇA	pg 087
LISTA DE VERIFICAÇÃO PRÉ-INSTALAÇÃO	pg 091
INSTALAÇÃO	pg 099
INSTRUÇÕES DE INSTALAÇÃO NO INVERNO	pg 099
UTILIZAÇÃO DO SPA	pg 103
MANUTENÇÃO	pg 106
DESMONTAGEM E ARMAZENAMENTO	pg 108
RESOLUÇÃO DE PROBLEMAS	pg 110
CÓDIGOS DE ERRO	pg 111

---



**VISITE O CANAL DA BESTWAY NO YOUTUBE**

PARA VÍDEOS COM INSTRUÇÕES  
POR FAVOR VISITE  
**[BESTWAYCORP.COM/SUPPORT](http://BESTWAYCORP.COM/SUPPORT)**

# INSTRUÇÕES IMPORTANTES DE SEGURANÇA

## ATENÇÃO INSTRUÇÕES DE SEGURANÇA IMPORTANTES

Quando utilizar este equipamento eléctrico devem ser sempre seguidas as precauções básicas de segurança, incluindo as seguintes:

### LEIA E SIGA TODAS AS INSTRUÇÕES.

**ATENÇÃO - PARA REDUZIR EVITAR O RISCO DE DANOS**, não permita que crianças usem este produto salvo se supervisionadas de perto a todo o momento. É fornecido um conector de cabo nesta unidade para ligar no mínimo um condutor de cobre sólido 6 AWG (13.3 mm<sup>2</sup>) entre esta unidade e qualquer equipamento de metal, revestimento metálico ou equipamento eléctrico, tubagem de água metálica ou conduta à distância de 1.5 m (5 pés) da unidade.

**PERIGO** - Risco de dano.

- Substitua um cabo danificado imediatamente.
- Não enterre o cabo.
- Ligue apenas a uma tomada de tipo terra com ligação à terra.

**ATENÇÃO** - Este produto é fornecido com um disjuntor de falha a terra integrado na ficha de alimentação na extremidade do cabo. O GFCI deve ser testado antes de cada utilização. Com o produto a funcionar, prima o botão de teste no GFCI e o produto não deve funcionar. Prima o botão reset no GFCI e o produto deve agora funcionar normalmente. Quando o produto não funciona desta forma, existe uma corrente de terra a fluir o que indica a possibilidade de um choque eléctrico. Desligue a alimentação até que a falha tenha sido identificada e corrigida.

**PERIGO** - Risco de Afogamento Acidental. Deve ser prestada uma extrema atenção para evitar acesso não autorizado pelas crianças. Para evitar acidentes, não permita que crianças usem a Spa a menos que alguém tome conta delas constantemente.

**PERIGO** - Risco de Dano. Os acessórios de sucção neste spa são dimensionados para se adequarem ao fluxo de água específico criado pela bomba. Caso surja a necessidade de substituir os acessórios de sucção ou a bomba, certifique-se que as taxas de fluxo são compatíveis. Nunca opere o spa caso os acessórios de sucção estejam partidos ou em falta. Nunca substitua um acessório de sucção por um classificado para uma taxa de fluxo inferior à do acessório de sucção original.

**PERIGO** - Risco de Choque Eléctrico. Instale a pelo menos 1.5 m (5 pés) de distância de quaisquer superfícies metálicas. Como alternativa, um spa pode ser instalado a menos de 1,5 m de superfícies metálicas caso cada superfície metálica esteja permanentemente ligada por um condutor de cobre sólido de no mínimo 6 AWG (13.3 mm<sup>2</sup>) ao cabo conector na caixa terminal que é fornecida para esse fim.

**PERIGO** - Risco de Choque Eléctrico. Não permita qualquer aparelho eléctrico, tal como um candeeiro, telefone, rádio ou televisão a menos de 1.5 m (5 pés) de um spa.

**ATENÇÃO** - Para reduzir evitar o risco de danos:

- A água na Spa nunca deve exceder 104°F (40°C). As temperaturas da água entre 100°F (38°C) e 104°F (40°C) são consideradas seguras para um adulto saudável. Temperaturas da água mais baixas são recomendadas para crianças e quando o uso da Spa exceder 10 minutos.
- Uma vez que as temperaturas muito altas podem potencialmente causar danos ao feto, durante os primeiros meses de gestação, durante a gestação ou se a mulher desconfiar que está grávida deve limitar a temperatura da água da Spa a 100°F (38°C).
- Antes de entrar num spa, o utilizador deve medir a temperatura da água com um termómetro preciso já que a tolerância dos dispositivos de regulação da temperatura da água varia.
- O uso de álcool, drogas ou medicamentos antes ou durante o uso da Spa pode levar ao estado de inconsciência com risco de afogamento.
- Pessoas obesas e pessoas com histórico de problemas cardíacos, problemas de

hipotensão ou hipertensão, problemas no sistema circulatório ou diabetes devem consultar um médico antes de usar a Spa.

- f) Pessoas que usam medicamentos devem consultar um médico antes de usar a Spa uma vez que a medicação pode levar ao adormecimento enquanto outras medicações podem afetar o batimento cardíaco, pressão arterial e circulação.

**ATENÇÃO: PARA EVITAR RISCOS DE CHOQUE ELÉTRICO, NÃO USE A SPA QUANTO ESTIVER CHOVENDO.**

**ATENÇÃO:** A água normalmente atrai a atenção das crianças; Sempre coloque a tampa da Spa depois de usá-la.

**ATENÇÃO: PARA REDUZIR EVITAR O RISCO DE DANOS:** Nunca adicione água que esteja a uma temperatura superior a 104°F (40°C) ao Spa.

## **CONSULTE O SEU MÉDICO PARA RECOMENDAÇÕES. CUIDADO:**

É altamente recomendável não abrir e encher o spa se a temperatura ambiente for inferior a 59°F (15°C). Sugerimos que encha o spa no interior e continue com a instalação no exterior. Se a temperatura exterior for inferior a 42,8°F (6°C), o aquecedor do spa deve estar sempre ligado. Deste modo, o sistema Freeze Shield™ pode manter a temperatura interior entre 42,8°F (6°C) e 50°F (10°C) para evitar danos, como o congelamento da água nos tubos ou no sistema de circulação.

**IMPORTANTE:** se o sistema Freeze Shield™ não estiver a funcionar, serão acionados alarmes no spa. Verifique o estado do seu spa se a temperatura exterior for inferior a 42,8°F (6°C). Em caso de ausência prolongada de casa, se existir risco de temperaturas abaixo de 42,8°F (6°C), sugerimos fortemente que desmonte o spa e o arrume de acordo com o procedimento de armazenamento.

**CUIDADO:** Não use a Spa quando estiver sozinho.

**CUIDADO:** Sempre entre e saia da Spa vagarosamente e com cuidado. Superfícies molhadas podem ser escorregadias.

**CUIDADO:** Para evitar danos à bomba, a Spa nunca deve ser colocada em funcionamento a menos que esteja cheia de água.

**CUIDADO:** Deixe a Spa imediatamente se estiver se sentindo não muito bem ou com sonolência.

**NOTA:** Por favor examine o equipamento antes do uso. Notifique sempre o serviço de assistência ao cliente elencado neste manual se houver partes danificadas ou em falta no momento da compra.

Verifique se os componentes do equipamento representam os modelos que você quer comprar.

## **SALVE ESSAS INSTRUÇÕES**

**ATENÇÃO:** AS CRIANÇAS NÃO DEVEM USAR SPAS OU BANHEIRAS DE HIDROMASSAGEM SEM SUPERVISÃO POR ADULTOS.

**ATENÇÃO:** NÃO USE SPAS OU BANHEIRAS DE HIDROMASSAGEM SALVO SE TODAS AS PROTEÇÕES DE SUÇÃO ESTIVEREM INSTALADAS PARA EVITAR O APRISIÓNAMENTO DO CABELO OU PARTES DO CORPO.

**ATENÇÃO:** AS PESSOAS QUE USEM MEDICAMENTOS E/OU TENHAM UM HISTÓRIAL MÉDICO ADVERSO DEVEM CONSULTAR UM MÉDICO ANTES DE USAR UM SPA OU BANHEIRA DE HIDROMASSAGEM.

**ATENÇÃO:** PESSOAS COM DOENÇAS INFECCIOSAS NÃO DEVEM USAR UM SPA OU BANHEIRA DE HIDROMASSAGEM.

**ATENÇÃO:** PARA EVITAR FERIMENTOS, TENHA CUIDADO QUANDO ENTRAR OU SAIR DO SPA OU BANHEIRA DE HIDROMASSAGEM.

**ATENÇÃO:** NÃO USE DROGAS OU ÁLCOOL ANTES OU DURANTE A UTILIZAÇÃO DO SPA OU BANHEIRA DE HIDROMASSAGEM PARA EVITAR A



PERDA DE CONSCIÊNCIA E POSSÍVEL AFOGAMENTO.

**ATENÇÃO:** AS MULHERES GRÁVIDAS OU QUE POSSAM ESTAR GRÁVIDAS DEVEM CONSULTAR UM MÉDICO ANTES DE USAR UM SPA OU BANHEIRA DE HIDROMASSAGEM.

**ATENÇÃO:** A TEMPERATURA DA ÁGUA SUPERIOR A 38°C PODE SER PREJUDICIAL PARA A SUA SAÚDE.

**ATENÇÃO:** ANTES DE ENTRAR NO SPA OU BANHEIRA DE HIDROMASSAGEM, MEÇA A TEMPERATURA DA ÁGUA COM UM TERMÓMETRO PRECISO.

**ATENÇÃO:** NÃO USE UM SPA OU BANHEIRA DE HIDROMASSAGEM IMEDIATAMENTE APÓS EXERCÍCIO FÍSICO EXTENUANTE.

**ATENÇÃO:** A IMERSÃO PROLONGADA NUM SPA OU BANHEIRA DE HIDROMASSAGEM PODE SER PREJUDICIAL PARA A SUA SAÚDE.

**ATENÇÃO:** NÃO PERMITA APARELHOS ELÉCTRICOS (TAIS COMO UM CANDÊEIRO, TELEFONE, RÁDIO OU TELEVISÃO) A MENOS DE 1.5 M DESTA SPA OU BANHEIRA DE HIDROMASSAGEM.

**CUIDADO:** MANTENHA A QUÍMICA DA ÁGUA DE ACORDO COM AS INSTRUÇÕES DO FABRICANTE.

**MONTAGEM: A ETIQUETA DE AVISO FORNECIDA**



## REDUZA O RISCO DE ELECTROCUSSÃO

1. NUNCA COLOQUE UM APARELHO ELÉCTRICO A MENOS DE 1.5 METROS DO SPA.

## REDUZA O RISCO DE AFOGAMENTO DE CRIANÇAS

1. SUPERVISE AS CRIANÇAS A TODO O MOMENTO.
2. PRENDA A TAMPA DO SPA APÓS CADA UTILIZAÇÃO.

## REDUZA O RISCO DE SOBREAQUECIMENTO

1. VERIFIQUE JUNTO DE UM MÉDICO ANTES DO USO CASO ESTEJA GRÁVIDA, SEJA DIABÉTICO, TENHA SAÚDE FRACA OU ESTEJA SUJEITO A TRATAMENTO MÉDICO.
2. SAIA IMEDIATAMENTE SE SE SENTIR DESCONFORTÁVEL, TONTO OU SONOLENTO. O CALOR DO SPA PODE CAUSAR HIPERTERMIA E INCONSCIÊNCIA.
3. O CALOR DO SPA EM CONJUNTO COM ÁLCOOL, DROGAS OU MEDICAMENTOS PODE CAUSAR INCONSCIÊNCIA.

**QUANDO ESTIVER GRÁVIDA,** A IMERSÃO EM ÁGUA QUENTE DURANTE LONGOS PERÍODOS PODE SER PREJUDICIAL PARA O FETO. MEÇA A TEMPERATURA DA ÁGUA ANTES DE ENTRAR.

1. NÃO ENTRE PARA O SPA CASO ESTE ESTEJA MAIS QUENTE QUE 100°F (38°C)
2. NÃO FIQUE NO SPA DURANTE MAIS DO QUE 10 MINUTOS.

**NOTA: A etiqueta de aviso deve ser colocada próximo do spa numa posição legível durante a utilização do seu spa.**

1. Remova a etiqueta de aviso do kit de acessórios.
2. Descole com cuidado a etiqueta de aviso.
3. Cole a etiqueta de aviso. Para encomendar a etiqueta de aviso, por favor contacte o seu serviço Pós-Venda Bestway local.

## LOCAL SELECIONADO

**IMPORTANTE:** Por causa do peso combinado da SaluSpa, da água e dos usuários, é muito importante que a base em que a SaluSpa está instalada seja macia, plana com nível e capacidade de suportar uniformemente este peso por todo o tempo no qual a SaluSpa estiver instalada (não em tapetes ou outros materiais semelhantes). Se a SaluSpa estiver colocada em uma superfície que não respeita essas exigências, qualquer dano causado pelo suporte impróprio não é coberto pela garantia do fabricante. É responsabilidade do proprietário da SaluSpa garantir perenemente a integridade do local.

### 1. Instalação em ambientes internos:

**Certifique-se das exigências especiais se você instalar a spa em um ambiente interno.**

- A umidade torna-se um efeito natural do ambiente com a instalação da SaluSpa. Determine os efeitos da umidade transportada pelo ar para a madeira ou papel expostos etc. no local ao redor. Para minimizar estes efeitos é melhor providenciar muita ventilação na área selecionada. Um arquiteto pode ajudar a determinar se mais ventilação se faz necessária.

### 2. Instalação em ambientes externos:

- Durante o abastecimento ou esvaziamento ou ainda durante o uso, a água pode respingar fora da Spa. Por isso a SaluSpa deve ser instalada próxima a um dreno no pavimento.
- Não deixe a superfície da Spa exposta à luz solar direta por longos períodos de tempo.

## ATENÇÃO GFCI

**IMPORTANTE:** RISCO DE CHOQUE ELÉTRICO. O GFCI DEVE SER TESTADO SEMPRE ANTES DE LIGAR A BOMBA.

**AVISO:** a ficha GFCI deve ser testada antes de cada utilização para evitar o risco de choque elétrico.

**AVISO:** antes de inserir a ficha numa tomada elétrica, verifique se a corrente nominal da tomada elétrica é adequada para a bomba.

**AVISO:** não utilize a bomba se este teste falhar. Para obter assistência, visite a seção de apoio no nosso sítio da internet: [www.bestwaycorp.com](http://www.bestwaycorp.com)

**AVISO:** a utilização de uma extensão ou de um adaptador multifichas com o aquecedor do spa pode causar o sobreaquecimento da ficha e danificar o equipamento e os itens em torno do mesmo. O spa é um aparelho elétrico de classe I e deve ser ligado diretamente a uma tomada com terra. É recomendável utilizar apenas uma tomada resistente à humidade e com capacidade para carga de alta potência. Verifique regularmente se a ficha e a tomada apresentam sinais de danos antes de utilizar o spa. Caso estejam danificadas, não utilize o spa. Se não tiver certeza sobre a qualidade do abastecimento elétrico, consulte um electricista qualificado antes de qualquer utilização.

# LISTA DE VERIFICAÇÃO PRÉ-INSTALAÇÃO

## VERIFICAÇÃO DAS PEÇAS

Examine o equipamento antes da utilização. Notifique o serviço de apoio ao cliente da Bestway® sobre quaisquer peças danificadas ou em falta no ato da compra. Verifique se os componentes do equipamento equivalem ao modelo que pretendia adquirir. Como referência, utilize os diagramas abaixo.

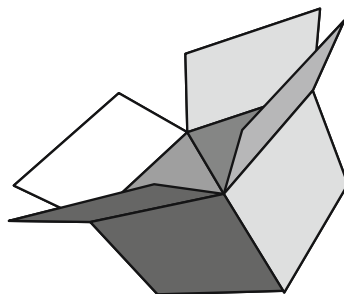

### MIAMI AIRJET S100104 (60002)

— 71" x 26" / 1.80 m x 66 cm



2 - 4



2-3°F/h  
1-1.5°C/h



320 gal/h  
1,211 L/h













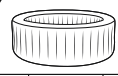

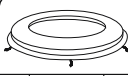



0.034-0.055Bar  
0.5-0.8PSI



177 gal  
669 L



1,534 Lb  
696 kg

 01 P06120 1	 02 P05333 1	 03 P06123 1	 04 54123GASS17 1	 05 P6931ASS16 1	 06 P05343 1
 07 P05345 1	 08 P05524 2	 09 F4C009B-02ASS17 1	 10 P00217 1	 11 P05320 6	 12 / 2
 13 P61726ASS18 1	 14 P61727ASS18 1	 15 P05346 1	 16 P6609ASS16 1		

# CANCUN AIRJET S100104 (60004)

— 71" x 26" / 1.80 m x 66 cm



2 - 4



2-3°F/h  
1-1.5°C/h



320 gal/h  
1,211 L/h



0.034-0.055Bar  
0.5-0.8PSI



177 gal  
669 L



1,534 Lb  
696 kg

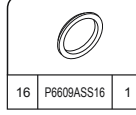
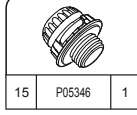
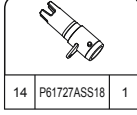
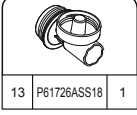
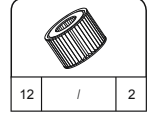
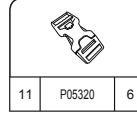
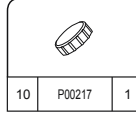
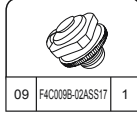
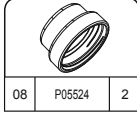
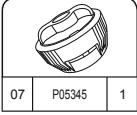
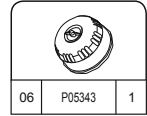
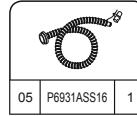
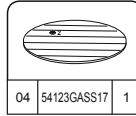
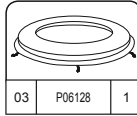
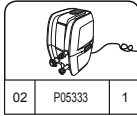
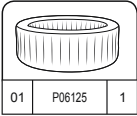

# BAHAMAS AIRJET S100104 (60006)

— 71" x 26" / 1.80 m x 66 cm



2 - 4



2-3°F/h  
1-1.5°C/h



320 gal/h  
1,211 L/h



0.034-0.055Bar  
0.5-0.8PSI



177 gal  
669 L



1,534 Lb  
696 kg

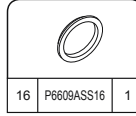
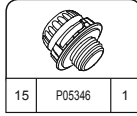
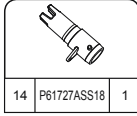
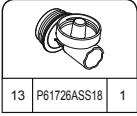
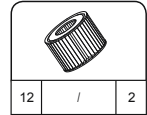
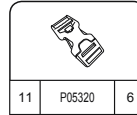
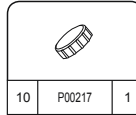
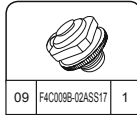
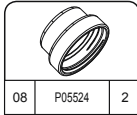
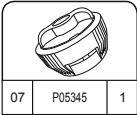
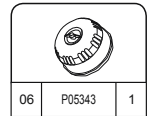
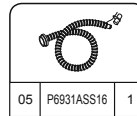
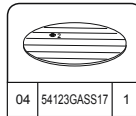
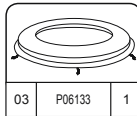
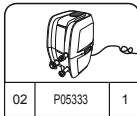
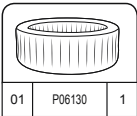

# TAHITI AIRJET S100104 (60008)

— 71" x 26" / 1.80 m x 66 cm



2 - 4



2-3°F/h  
1-1.5°C/h



320 gal/h  
1,211 L/h



0.034-0.055Bar  
0.5-0.8PSI



177 gal  
669 L



1,534 Lb  
696 kg

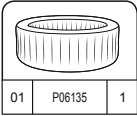

01 P06135 1

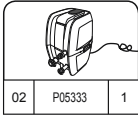

02 P05333 1

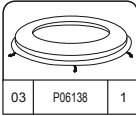

03 P06138 1

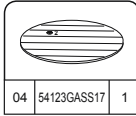

04 54123GASS17 1

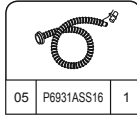

05 P6931ASS16 1

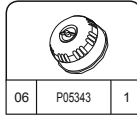

06 P05343 1

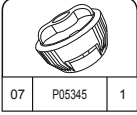

07 P05345 1

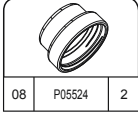

08 P05524 2

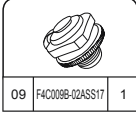

09 F4C009B-02ASS17 1

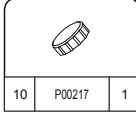

10 P00217 1

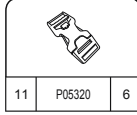

11 P05320 6

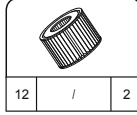

12 / 2

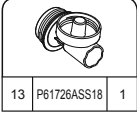

13 P61726ASS18 1

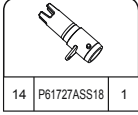

14 P61727ASS18 1

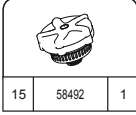

15 58492 1

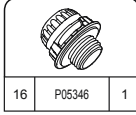

16 P05346 1

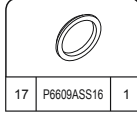

17 P6609ASS16 1

# BALI AIRJET S100104 (60010)

— 71" x 26" / 1.80 m x 66 cm



2 - 4



2-3°F/h  
1-1.5°C/h



320 gal/h  
1,211 L/h



0.034-0.055Bar  
0.5-0.8PSI



177 gal  
669 L



1,534 Lb  
696 kg

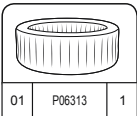

01 P06313 1

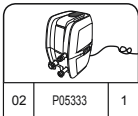

02 P05333 1

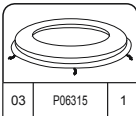

03 P06315 1

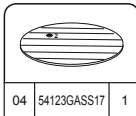

04 54123GASS17 1

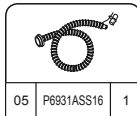

05 P6931ASS16 1

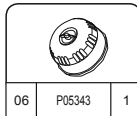

06 P05343 1

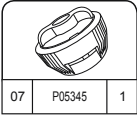

07 P05345 1

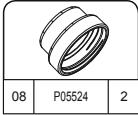

08 P05524 2

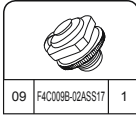

09 F4C009B-02ASS17 1

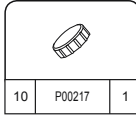

10 P00217 1

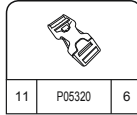

11 P05320 6

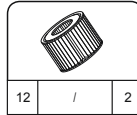

12 / 2

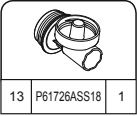

13 P61726ASS18 1

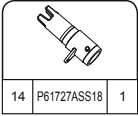

14 P61727ASS18 1

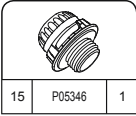

15 P05346 1

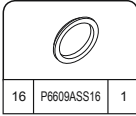

16 P6609ASS16 1

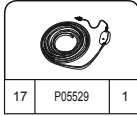

17 P05529 1

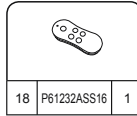

18 P61232ASS16 1

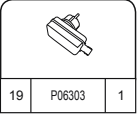

19 P06303 1

## IBIZA AIRJET S100104 (60016)

— 71" x 71" x 26" / 1.80 m x 1.80 m x 66 cm



4 - 6



2-3°F/h  
1-1.5°C/h



320 gal/h  
1,211 L/h



0.034-0.055Bar  
0.5-0.8PSI



205 gal  
778 L



1,779 Lb  
807 kg

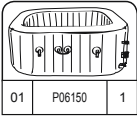

01 P06150 1

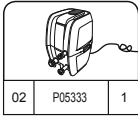

02 P05333 1

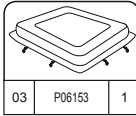

03 P06153 1

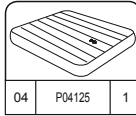

04 P04125 1

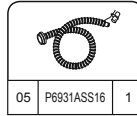

05 P6931ASS16 1

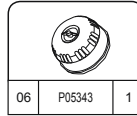

06 P05343 1

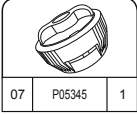

07 P05345 1

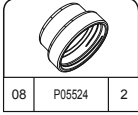

08 P05524 2

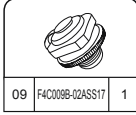

09 F4C009B-02ASS17 1

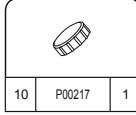

10 P00217 1

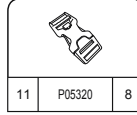

11 P05320 8

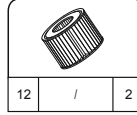

12 / 2

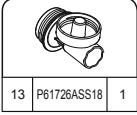

13 P61726ASS18 1

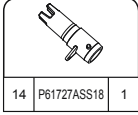

14 P61727ASS18 1

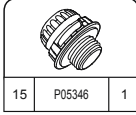

15 P05346 1

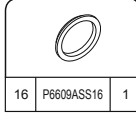

16 P6609ASS16 1

## PALM SPRINGS AIRJET S100104 (60018)

— 77" x 28" / 1.96 m x 71 cm



4 - 6



2-3°F/h  
1-1.5°C/h



320 gal/h  
1,211 L/h



0.08Bar  
1.2PSI



242 gal  
916 L



2,103 Lb  
954 kg

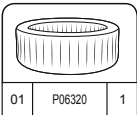

01 P06320 1

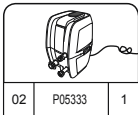

02 P05333 1

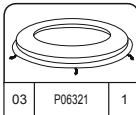

03 P06321 1

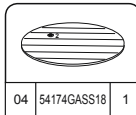

04 54174GASS18 1

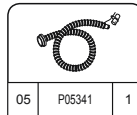

05 P05341 1

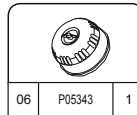

06 P05343 1

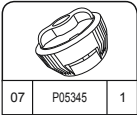

07 P05345 1

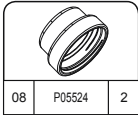

08 P05524 2

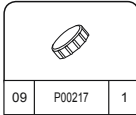

09 P00217 1

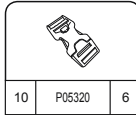

10 P05320 6

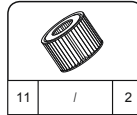

11 / 2

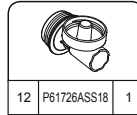

12 P61726ASS18 1

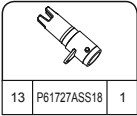

13 P61727ASS18 1

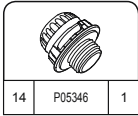

14 P05346 1

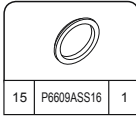

15 P6609ASS16 1

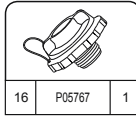

16 P05767 1

## HONOLULU AIRJET S100104 (60020)

— 77" x 28" / 1.96 m x 71 cm



4 - 6



2-3°F/h  
1-1.5°C/h



320 gal/h  
1,211 L/h













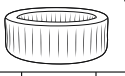

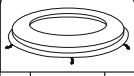

0.08Bar  
1.2PSI

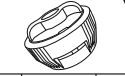

242 gal  
916 L

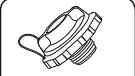

2,103 Lb  
954 kg

 01 P05191 1	 02 P05333 1	 03 P05195 1	 04 54174GASS18 1	 05 P05341 1	 06 P05343 1
 07 P05345 1	 08 P05524 2	 09 P00217 1	 10 P05320 6	 11 / 2	 12 P61726ASS18 1
 13 P61727ASS18 1	 14 P05346 1	 15 P6609ASS16 1	 16 P05767 1		

## HAWAII AIRJET S100104 (60022)

— 71" x 71" x 28" / 1.80 m x 1.80 m x 71 cm



4 - 6



2-3°F/h  
1-1.5°C/h



320 gal/h  
1,211 L/h















0.08Bar  
1.2PSI



222 gal  
840 L

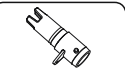
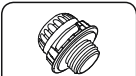
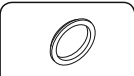
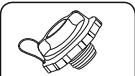

1,938 Lb  
879 kg

 01 P05185 1	 02 P05333 1	 03 P05189 1	 04 P04125 1	 05 P05341 1	 06 P05343 1
 07 P05345 1	 08 P05524 2	 09 P00217 1	 10 P05320 8	 11 / 2	 12 P61726ASS18 1
 13 P61727ASS18 1	 14 P05346 1	 15 P6609ASS16 1	 16 P05767 1		

## ST. MORITZ AIRJET S100104 (60024)

— 85" x 28" / 2.16 m x 71 cm



5 - 7



1-2°F/h  
0.5-1°C/h



320 gal/h  
1,211 L/h











0.08Bar  
1.2PSI

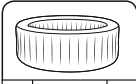

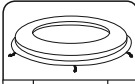
314 gal  
1190 L

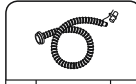

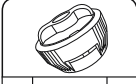
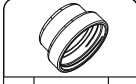
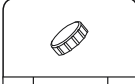
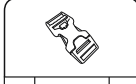
2,668 Lb  
1210 kg

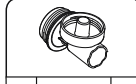
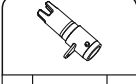
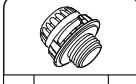
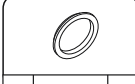
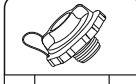
					
01 P05197 1	02 P05333 1	03 P05201 1	04 54175GASS18 1	05 P05341 1	06 P05343 1
					
07 P05345 1	08 P05524 2	09 P00217 1	10 P05320 8	11 / 2	12 P61726ASS18 1
					
13 P61727ASS18 1	14 P05346 1	15 P6609ASS16 1	16 P05767 1		

## HELSINKI AIRJET S100104 (60026)

— 71" x 26" / 1.80 m x 66 cm



5 - 7



1-2°F/h  
0.5-1°C/h



320 gal/h  
1,211 L/h











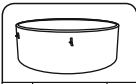
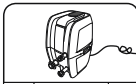
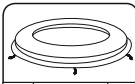

0.48-0.69Bar  
7-10PSI

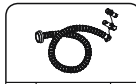

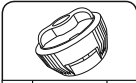
297 gal  
1123 L

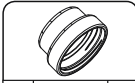
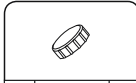
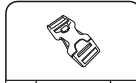

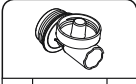
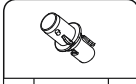
2,548 Lb  
1155 kg

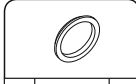
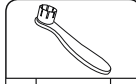
					
01 P05203 1	02 P05333 1	03 P05207 1	04 P04122 1	05 P05482 1	06 P05343 1
					
07 P05345 1	08 P06327 1	09 P05524 2	10 P00217 1	11 P05320 6	12 / 2
					
13 P61726ASS18 1	14 P05344 1	15 P05346 1	16 P6609ASS16 1	17 / 1	



# ST.LUCIA AIRJET S100104 (60038)

— 67" x 26" / 1.70 m x 66 cm



2 - 3



2-3°F/h  
1-1.5°C/h



320 gal/h  
1,211 L/h















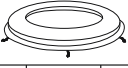



0.034-0.055Bar  
0.5-0.8PSI



160 gal  
605 L



1,389 Lb  
630 kg

 01 P06158 1	 02 P05333 1	 03 P06164 1	 04 P05091 1	 05 P6931ASS16 1	 06 P05343 1
 07 P05345 1	 08 P05524 2	 09 F4C009B-02ASS17 1	 10 P00217 1	 11 P05320 5	 12 / 2
 13 P61726ASS18 1	 14 P61727ASS18 1	 15 P05346 1	 16 P6609ASS16 1		

# HOLLYWOOD AIRJET S100104 (60060)

— 77" x 26" / 1.96 m x 66 cm



4 - 6



2-3°F/h  
1-1.5°C/h



320 gal/h  
1,211 L/h















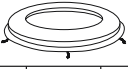







0.034-0.055Bar  
0.5-0.8PSI



240 gal  
908 L



2,066 Lb  
937 kg

 01 P06199 1	 02 P05333 1	 03 P06202 1	 04 54112GASS15 1	 05 P6931ASS16 1	 06 P05343 1
 07 P05345 1	 08 P05524 2	 09 F4C009B-02ASS17 1	 10 P00217 1	 11 P05320 6	 12 / 2
 13 P61726ASS18 1	 14 P61727ASS18 1	 15 P05346 1	 16 P6609ASS16 1	 17 P05513 1	 18 P61232ASS16 1
 19 P06303 1	 20 P06280 4				

# ARUBA AIRJET S100104 (60062)

— 67" x 26" / 1.70 m x 66 cm



2 - 3



2-3°F/h  
1-1.5°C/h



320 gal/h  
1,211 L/h













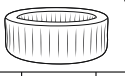

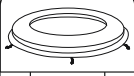

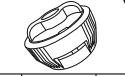

0.034-0.055Bar  
0.5-0.8PSI



160 gal  
605 L



1,389 Lb  
630 kg

 01 P06161 1	 02 P05333 1	 03 P06166 1	 04 P05091 1	 05 P6931ASS16 1	 06 P05343 1
 07 P05345 1	 08 P05524 2	 09 F4C009B-02ASS17 1	 10 P00217 1	 11 P05320 5	 12 / 2
 13 P61726ASS18 1	 14 P61727ASS18 1	 15 P05346 1	 16 P6609ASS16 1		

# FIJI AIRJET S100104 (60086)

— 71" x 26" / 1.80 m x 66 cm



2 - 4



2-3°F/h  
1-1.5°C/h



320 gal/h  
1,211 L/h













0.034-0.055Bar  
0.5-0.8PSI

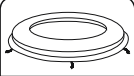
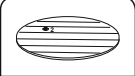

177 gal  
669 L

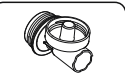
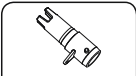
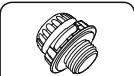
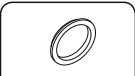

1,534 Lb  
696 kg

 01 P06282 1	 02 P05333 1	 03 P06285 1	 04 54123GASS17 1	 05 P6931ASS16 1	 06 P05343 1
 07 P05345 1	 08 P05524 2	 09 F4C009B-02ASS17 1	 10 P00217 1	 11 P05320 6	 12 / 2
 13 P61726ASS18 1	 14 P61727ASS18 1	 15 P05346 1	 16 P6609ASS16 1		

# INSTALAÇÃO



## INSTRUÇÕES DE INSTALAÇÃO NO INVERNO

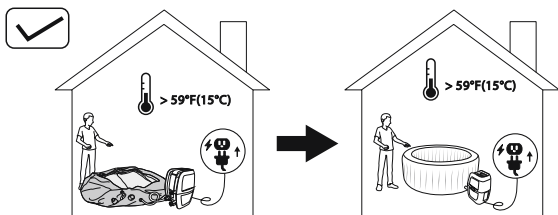
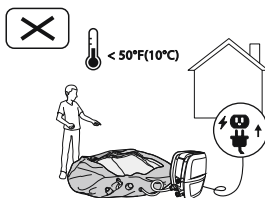

É importante seguir estas sugestões se decidir instalar o spa durante o período de inverno. Isto evita danos no material de PVC e prolonga significativamente a vida útil do produto.

- Se a temperatura ambiente for inferior a 50°F (10°C), sugerimos que mantenha a embalagem no interior, onde a temperatura seja superior a 59°F (15°C), durante, pelo menos, 2 horas antes do enchimento. Isto permite que o revestimento do spa fique mais flexível e fácil de instalar.
- Abra a embalagem na mesma sala com temperatura superior a 59°F (15°C) e encha o spa utilizando o aquecedor do spa.
- Posicione o revestimento do spa no exterior, na posição pretendida, ligue o aquecedor do spa e encha com água.

**Importante:** a temperatura da água utilizada para encher o spa deve ser superior a 42,8°F (6°C); caso contrário, quando começar a utilizar o aquecedor, é apresentado o alarme E03.

**Importante:** se o sistema Freeze Shield™ não estiver a funcionar, serão acionados alarmes no spa. Verifique o estado do seu spa se a temperatura exterior for inferior a 42,8°F (6°C). Em caso de ausência prolongada de casa, se existir risco de temperaturas abaixo de 42,8°F (6°C), sugerimos fortemente que desmonte o spa e o arrume de acordo com o procedimento de armazenamento. Quando montar o spa, a função de aquecimento automático liga-se. Nesta condição, o spa pode ser utilizado quando a temperatura for inferior a 42,8°F (6°C).

**NOTA:** O manómetro de ar na bomba manual mostra a pressão de ar apenas quando está acima de 5 psi, o que é normal. Quando a pressão do ar no produto for inferior a 5 psi, o medidor de pressão do ar não exibirá um valor (somente spas de ponto baixo).

1

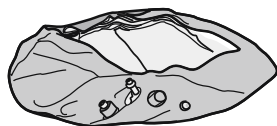

2



3

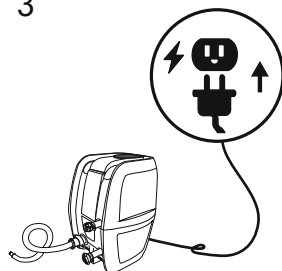

4

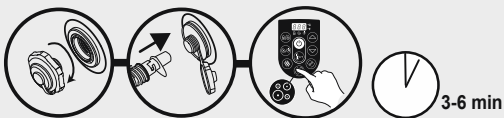
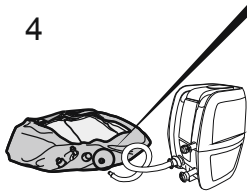

3-6 min

HELSINKI



0.48-0.69Bar  
7-10PSI



HOLLYWOOD BALI

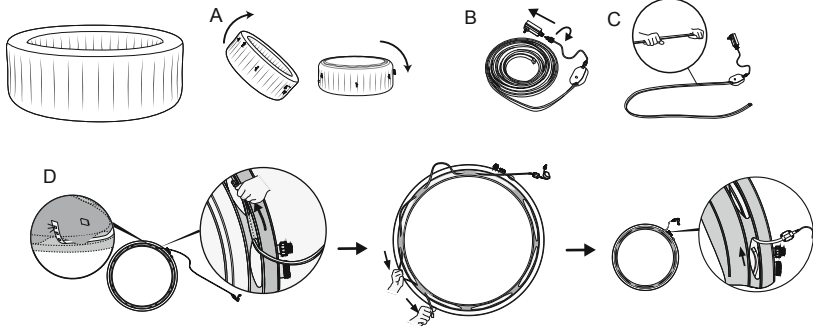

5

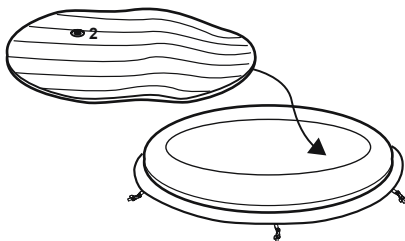

6

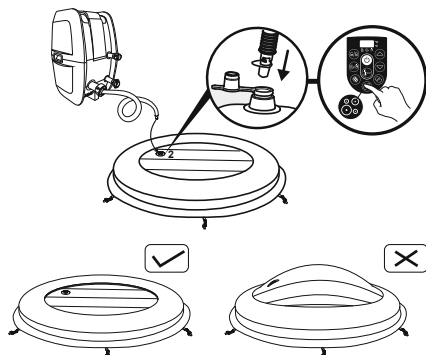

7

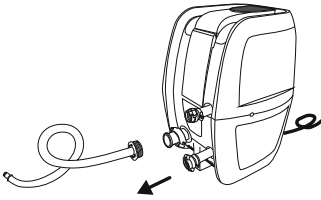

8

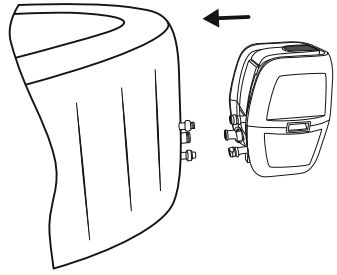

9

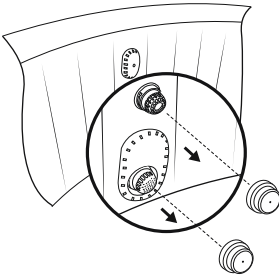

10

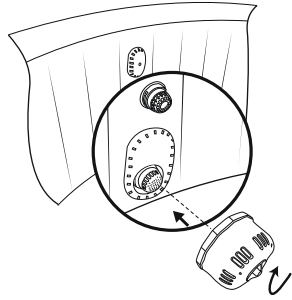

11.1



11.2 HOLLYWOOD

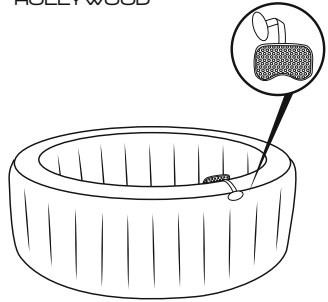

### GFCI TEST

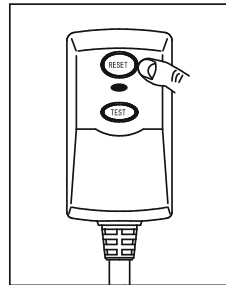
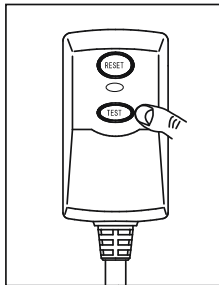
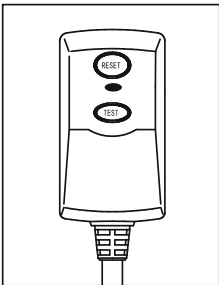

Durante o enchimento, notará que o ar é expelido da área onde a mangueira de ar se liga à bomba. Isto é normal de acordo com os requisitos técnicos.

**Importante:** não cubra os orifícios na base da mangueira de enchimento. Esta operação vai encher excessivamente o revestimento e danificar a estrutura.

Não utilize um compressor de ar para encher a piscina.

Não arraste a piscina através de terrenos irregulares, pois pode causar danos no revestimento.

Tempo de enchimento apenas para referência.

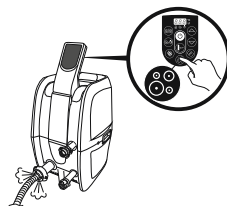

### Verificação da válvula de ar (para spa com válvula de enchimento/esvaziamento rápido)

Verifique sempre cuidadosamente a válvula de ar antes do enchimento para garantir que não existem fugas de ar. Se a válvula de ar estiver solta, utilize a chave fornecida para a apertar seguindo estes passos:

Com uma mão, segure a parte de trás da válvula de ar do lado interno da parede do spa e rode a chave no sentido dos ponteiros do relógio.

#### NOTA:

1. Não aperte demasiado.
2. Não ajuste o conector da válvula de ar quando o spa estiver a ser utilizado.

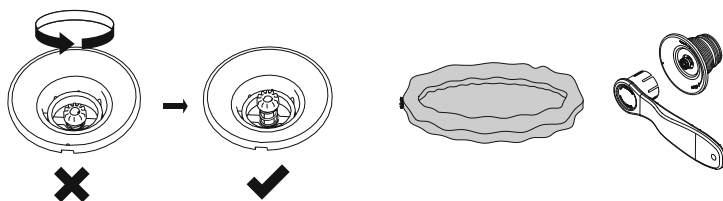

# UTILIZAÇÃO DO SPA

A hipertermia ocorre quando a temperatura interna do corpo alcança um nível vários graus acima da temperatura normal do corpo de 98,6°F (37°C). Os sintomas da hipertermia incluem um aumento da temperatura interna do corpo, tonturas, letargia, sonolência e desmaios. Os efeitos da hipertermia incluem a falha de percepção do calor, falha em reconhecer a necessidade de sair do spa ou banheira de hidromassagem; inconsciência do perigo imediato; danos fetais em mulheres grávidas; incapacidade física em sair do spa ou da banheira de hidromassagem; e inconsciência resultando em perigo de afogamento.

**AVISO:** A utilização de álcool, drogas ou medicamentos pode aumentar significativamente o risco de hipertermia fatal.

**AVISO:** A TEMPERATURA DA ÁGUA ACIMA DOS 100°F (38°C) PODE SER NOCIVA PARA A SUA SAÚDE.

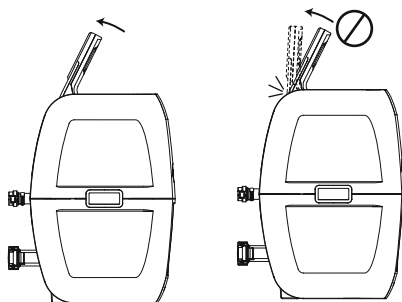

**A. BOTÃO DE BLOQUEIO/DESBLOQUEIO:** a bomba tem um bloqueio automático de 5 minutos. Esta luz acende-se. Para bloquear ou desbloquear a bomba, coloque um dedo sobre o botão de bloqueio/desbloqueio durante 3 segundos.



**B. BOTÃO DO TEMPORIZADOR DE POUANÇA DE ENERGIA:** concebido para ajudar a evitar desperdício de energia, definindo a hora e a duração do ciclo de aquecimento do spa. Desta forma, pode desfrutar do seu spa no momento que desejar, sem precisar de deixar o aquecedor ligado o tempo todo.

PASSO 1: configure a duração do aquecimento

1. Prima o botão da unidade, o LED fica intermitente.
2. Prima o botão ou para ajustar o tempo de aquecimento (1-999 horas).
3. Prima novamente o botão para confirmar o tempo do aquecimento.

PASSO 2: defina o número de horas a PARTIR DE AGORA quando o aquecedor deve ser ativado

1. Depois de definir tempo de aquecimento, o LED fica intermitente.
2. Prima o botão ou para ajustar as horas até ao momento de ativação (0-999 horas).
3. Prima novamente o botão ou simplesmente não toque em nada durante 10 segundos para confirmar a definição. O LED acende-se de forma fixa e a contagem decrescente para a ativação do aquecedor é iniciada. Para alterar as definições do temporizador: Prima o botão e utilize o botão ou para ajustar. Cancelar a configuração: Prima o botão durante 2 segundos.

**NOTA:** após a configuração, o ecrã apresenta a temperatura e a hora atuais a piscar e alternadamente.

**NOTA:** o temporizador (quantidade de tempo com o aquecedor ligado) pode ser definido de 1 a 999 horas; o tempo de reserva (o número de horas PARTIR DE AGORA quando o aquecedor começa a funcionar) pode ser definido de 0 a 999 horas. Se o temporizador for definido em 0 horas, o sistema de aquecimento será ativado imediatamente. De notar que o temporizador é de utilização única, o utilizador define a duração do ciclo de aquecimento e quantas horas a partir de agora tem início o ciclo de aquecimento. O temporizador NÃO se repete até ser reinicializado.



**C. BOTÃO DE AQUECIMENTO:** utilize este botão para ativar o sistema de aquecimento. Quando a luz acima do botão de aquecimento estiver vermelha, o sistema de aquecimento é ativado. Quando a luz estiver verde, a água está à temperatura definida e o sistema de aquecimento está em repouso.

**NOTA:** se o sistema de aquecimento for ativado, o sistema de filtragem será iniciado automaticamente.

**NOTA:** depois de desligar o sistema de aquecimento, o sistema de filtragem continuará a funcionar.

**NOTA:** se o aquecedor do spa estiver ligado quando a temperatura da água for inferior a 42,8°F(6°C), o sistema de aquecimento aquece automaticamente a água até 50°F (10°C).



**D. BOTÃO DO SISTEMA DE MASSAGEM:** utilize este botão para ativar o sistema de massagem, que possui uma função de desativação automática de 30 minutos. A luz acima do botão do sistema Massage é apresentada a vermelho quando ativada.

**IMPORTANTE:** não utilize o sistema Massage com a cobertura colocada. O ar pode acumular-se no interior do spa e causar danos irreparáveis na cobertura e lesões físicas.

**NOTA:** o sistema de aquecimento e massagem trabalha em conjunto para criar uma experiência de massagem quente.



**E/G. BOTÕES DE AJUSTE DA TEMPERATURA:** se premir os botões de aumento ou redução da temperatura, o LED pisca. Quando estiver a piscar, pode ajustar a temperatura pretendida. Se mantiver estes botões premidos, os valores aumentam ou diminuem rapidamente. A configuração da temperatura nova e pretendida permanecerá no visor LED durante 3 segundos para confirmar o novo valor.

**NOTA:** a temperatura predefinida é de 95°F (35°C).

**NOTA:** o ajuste da temperatura varia entre 68°F (20°C) e 104°F (40°C).



**F. BOTÃO LIGAR/DESLIGAR:** prima este botão durante 2 segundos para ativar os botões do painel de controlo e a luz acende-se a verde. Prima este botão durante 2 segundos para desligar todas as funções atualmente ativadas.



**H. ALTERNÂNCIA ENTRE CELSIUS/FAHRENHEIT:** a temperatura pode ser apresentada em Fahrenheit ou Celsius.



**I. BOTÃO DO FILTRO DE ÁGUA:** este botão liga e desliga a bomba do filtro. A luz acima do botão do filtro de água é apresentada a vermelho quando ativada.



#### **LED DO TEMPORIZADOR DE POUANÇA DE ENERGIA:**

Este LED a piscar significa que está a definir o tempo de aquecimento. A luz acender-se-á quando a função de aquecimento começar a funcionar.



Este LED a piscar significa que está definir o número de horas a PARTIR DE AGORA quando o aquecedor deve ser ativado. Quando a luz está acesa, a função do temporizador de poupança de energia está definida.

**NOTA:** a TAXA DE AQUECIMENTO da água pode mudar nas condições abaixo:

- Quando a temperatura exterior for inferior a 59°F (15°C).
- Se a cobertura não estiver na posição quando a função de aquecimento estiver ativada.

**NOTA:** para visualizar a temperatura atual da água, acione o sistema de filtragem durante pelo menos um minuto.

A temperatura da água testada por um termómetro externo pode variar da temperatura apresentada no painel do spa até aproximadamente 35,6°F (2°C).



## INSTRUÇÕES DE UTILIZAÇÃO NO INVERNO



- Pode manter o spa ligado durante o inverno quando a temperatura for inferior a 42,8°F (6°C). O sistema Freeze Shield™ mantém automaticamente a temperatura da água entre 42,8°F (6°C) e 50°F (10°C) e evita que a água congele.  
**Importante:** se a temperatura da água for inferior a 42,8°F (6°C), o aquecedor do spa deve estar sempre ligado. Deste modo, o sistema Freeze Shield™ pode manter a temperatura interior entre 42,8°F (6°C) e 50°F (10°C) para evitar danos, como o congelamento da água nos tubos ou no sistema de circulação.  
**Importante:** se o sistema Freeze Shield™ não estiver a funcionar, serão acionados alarmes no spa. Verifique o estado do seu spa se a temperatura exterior for inferior a 42,8°F (6°C). Em caso de ausência prolongada de casa, se existir risco de temperaturas abaixo de 42,8°F (6°C), sugerimos fortemente que desmonte o spa e o arrume de acordo com o procedimento de armazenamento.
- Qualquer dano resultante da utilização do spa nestas condições é da responsabilidade do cliente. Não utilize o spa quando a temperatura ambiente atingir 14°F (-10°C).

## IMPORTANTE

Para atingir os 104°F (40°C), o tempo de aquecimento necessário baseia-se na temperatura inicial da água e na temperatura ambiente; os dados abaixo servem apenas como referência. Para visualizar a temperatura atual da água, acione o sistema de filtragem durante pelo menos um minuto.

Temperatura ambiente	Temperatura da água	Temperatura definida	Tempo de aquecimento
50°F(10°C)	50°F(10°C)	104°F(40°C)	32 h
59°F(15°C)	59°F(15°C)	104°F(40°C)	26 h
68°F(20°C)	68°F(20°C)	104°F(40°C)	20 h
77°F(25°C)	77°F(25°C)	104°F(40°C)	14 h
86°F(30°C)	86°F(30°C)	104°F(40°C)	9 h

- Certifique-se de que cobre o spa com a cobertura sempre que a função de aquecimento estiver ativada. Se deixar o spa descoberto, aumenta o tempo de aquecimento necessário.
- Quando o spa estiver montado com água, não desligue o aquecedor do spa se a temperatura for inferior a 42,8°F (6°C).

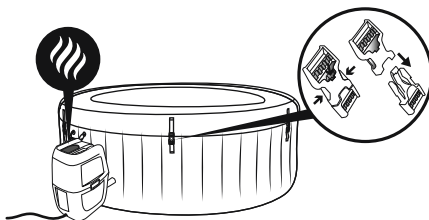

Potência	Ventilador do tubo de massagem	Resistência	Bomba de água
110-120 VCA, 60Hz, monofásica 12 A a 20°C	6.5A	11,3A a 20°C	0.7A

# MANUTENÇÃO

**CUIDADO:** deve certificar-se de que a bomba está desligada antes de iniciar a manutenção do spa, para evitar risco de lesões ou morte.

**Adição de ar:** o seu spa necessitará de ar adicional de tempos em tempos.

As alterações na temperatura do dia para a noite irão alterar a pressão no spa e podem causar uma certa deflação. Siga as instruções de montagem e encha para obter a pressão precisa necessária.

Quando tiver de utilizar a bomba para o enchimento, bloqueie as mangueiras para evitar a fuga de água e, de seguida, desligue a bomba e enrosque a tampa (P00217) para evitar que a água saia do tubo de ar.

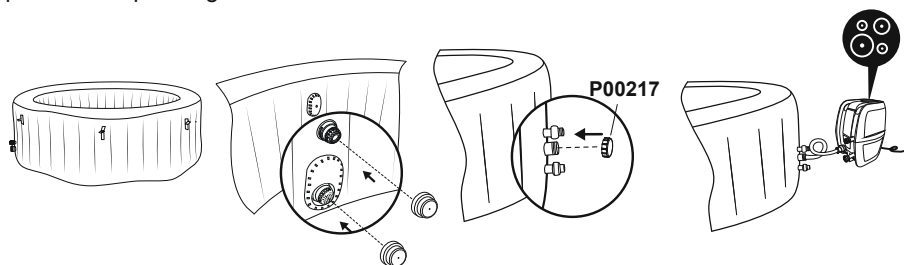

## Manutenção da cobertura

A cobertura deve ser limpa dentro e fora periodicamente, utilizando uma solução adequada que inclua desinfecção apropriada (por exemplo, 10 mg/l de cloro livre).

## Manutenção do cartucho do filtro

Para garantir que a água do seu spa permanece limpa, verifique e limpe os cartuchos do filtro todos os dias seguindo os passos abaixo.

**NOTA:** é recomendável substituir os cartuchos do filtro todas as semanas ou, se os cartuchos do filtro estiverem sujos e descolorados, devem ser substituídos.



## Manutenção da água

Muitos poluentes da água instalam-se nas superfícies abaixo da linha de água. Estes poluentes podem causar o crescimento de bactérias, algas ou fungos. Recomenda-se que os spas sejam limpos regularmente, conforme necessário. Decorrido algum tempo, podem surgir manchas ou biopelículas persistentes nas superfícies acessíveis abaixo da linha de água ou podem também ocorrer concentrações elevadas de sais ou subprodutos de reação indesejados. Consoante o estado de higiene, a limpeza, a visibilidade, os odores, os detritos e as manchas, é recomendável substituir completamente a água e limpar/desinfetar o spa. Ao esvaziar o spa, devem ser observados os regulamentos e as instruções para drenagem da água. É necessário manter a água do seu spa limpa e quimicamente equilibrada. Não basta limpar o cartucho do filtro para uma manutenção adequada; é recomendável utilizar produtos químicos de piscina para manter a química da água e pastilhas de cloro ou bromo (não utilize grânulos) com o dispensador de produtos químicos. A qualidade da água esta

diretamente relacionada com frequência de utilização, o número de utilizadores e a manutenção geral do spa. A água deve ser substituída todos os 3 dias se não existir tratamento químico da água. É altamente recomendável utilizar água da torneira para o enchimento de spa a fim de minimizar a influência de conteúdos indesejados, como minerais. As áreas para andar descalço e as áreas de repouso também devem ser limpas. Nenhuma água de limpeza pode penetrar no spa ou no ciclo de água do spa. A sujidade e os agentes de limpeza devem ser lavados com cuidado para drenar o ambiente do spa.

**Nota:** é recomendável tomar um duche antes de utilizar o SaluSpa, pois os cosméticos, as loções e outros resíduos da pele podem degradar rapidamente a qualidade da água. Para utilizar o dispensador de produtos químicos, siga as instruções abaixo.

### Utilização de pastilhas químicas (não incluídas):

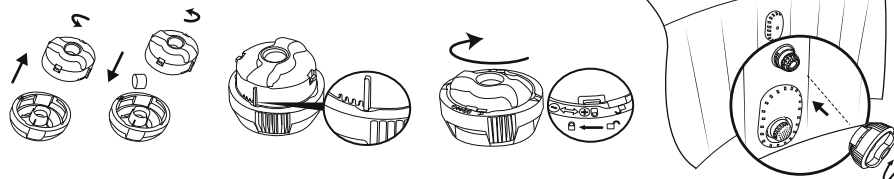

**Importante:** não utilize pastilhas granuladas nem deite a pastilha diretamente na água, pois o produto químico vai depositar-se no fundo e danificar o material e descolorar o PVC.

### Utilização de líquidos químicos (não incluídos):

**Importante:** adicione líquido químico em pequenas doses e no centro da piscina. Evite o contacto direto do produto químico com a superfície do spa; o contacto direto do produto químico com o material do spa vai danificar o material e descolorar a superfície.

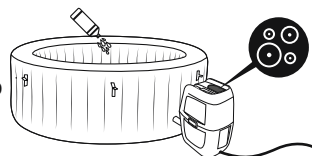

**NOTA:** retire o dispensador de produtos químicos do spa quando o spa estiver em utilização.

**IMPORTANTE:** depois de realizar a manutenção química e antes de utilizar o spa, utilize um kit de teste (não incluído) para testar a química da água. É recomendável manter a água conforme indicado na tabela abaixo.

pH	Alcalinidade total	Cloro livre
7,4-7,6	80-120ppm	2-4ppm

**NOTA:** danos resultantes de desequilíbrio químico não são cobertos pela garantia. Os produtos químicos da piscina são potencialmente tóxicos e devem ser manuseados com cuidado. Existem sérios riscos para a saúde causados por vapores químicos e pela rotulagem e armazenamento incorretos de recipientes de produtos químicos. Consulte o seu revendedor local de abastecimento de piscinas para obter mais informações sobre a manutenção química. Preste muita atenção às instruções do fabricante do produto químico. Danos no spa resultantes da utilização indevida de produtos químicos e da gestão incorreta da água do spa não são cobertos pela garantia.

**Importante:** a utilização excessiva de produtos químicos descolora o estampado e todos os pontos do material do spa e, na pior das hipóteses, danifica a estrutura do revestimento do spa.

# DESMONTAGEM E ARMAZENAMENTO

## ESVAZIAMENTO DO SPA

1.

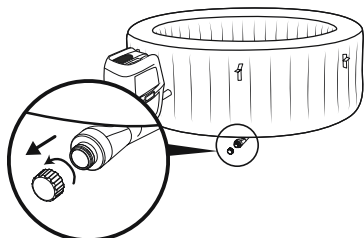

2.

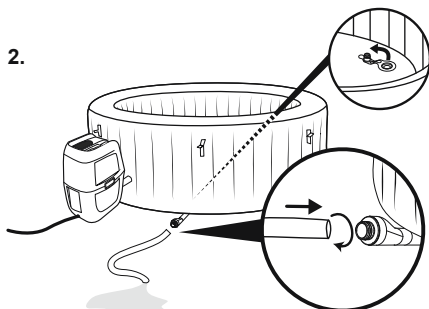

3. **NOTA:** seque a piscina do spa.



4.

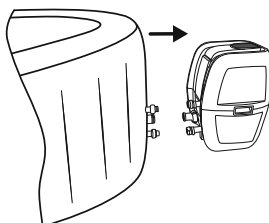

5.

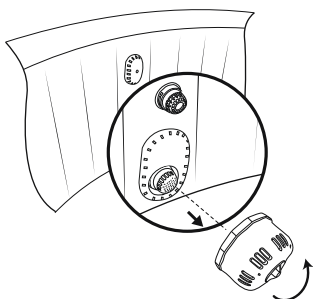

6.

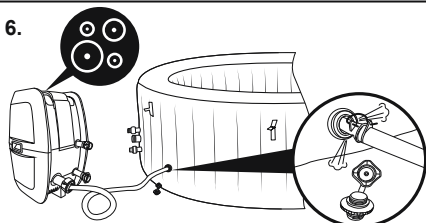

Para os spas de Bali e Hollywood:  
Você pode encontrar vapor dentro da câmara de ar e mofo após o armazenamento se houver água dentro. Desparafuse a válvula e use o tubo para soprar na câmara de ar até que todo o vapor interno esteja seco. Esta operação pode levar de 2 a 5 horas

## Apenas para spa Drop Stitch

1.



2.

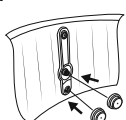

3.

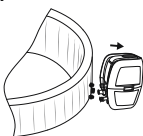

4.

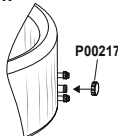

5.

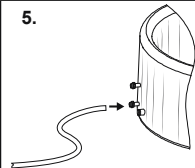

6.

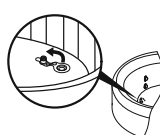
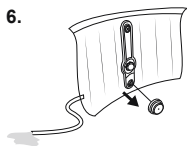

**NOTA:** levante o spa quando quantidade de água for reduzida. Os danos nas pegas não estão cobertos.

8. **NOTA:**

seque a piscina do spa.



Certifique-se de que o spa e a bomba estão completamente secos. Isto é essencial para prolongar o tempo de vida útil do spa. É recomendável utilizar a bomba para secar o spa, a bomba e os tubos. Remova os conjuntos de filtros e elimine os cartuchos do filtro usados. Coloque novamente os dois tampões nas válvulas de entrada e saída do spa. É recomendável armazenar o spa na sua embalagem original, num local quente [acima dos 59°F (15°C)] e seco.

## LIMPEZA DO SPA

Os resíduos de detergente e os sólidos dissolvidos de roupas de banho e os produtos químicos podem acumular-se nas paredes do spa. Utilize sabão e água para limpar as paredes e enxague bem.

**NOTA:** NÃO utilize escovas duras ou limpadores abrasivos.

## ESVAZIAMENTO

O seu spa está equipado com uma função de esvaziamento para remover todo o ar do interior da câmara e facilitar a embalagem e o armazenamento.

Válvula de parafuso

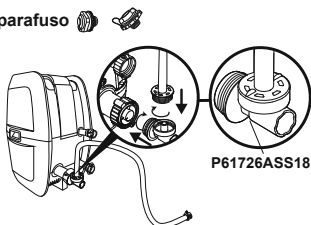

P61727ASS18

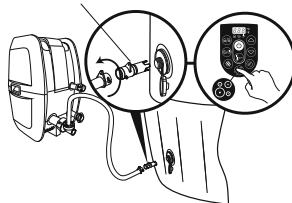

Válvula de enchimento/esvaziamento rápido

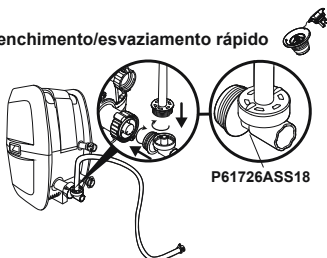

P05344

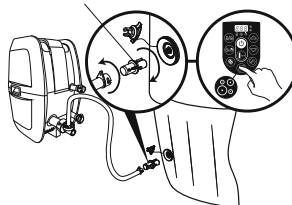

## REPARAÇÃO

### Para o componente em PVC.

Se o spa estiver rasgado ou furado, utilize o remendo adesivo subaquático fornecido.

1. Limpe a área a ser reparada.
2. Descole cuidadosamente o remendo.
3. Pressione o remendo sobre a área a ser reparada.
4. Aguarde 30 segundos antes de encher.

### Para o material TriTech PVC.

Se o spa estiver rasgado ou furado, utilize o remendo de reparação de PVC fornecido e cola (não incluída), e siga os seguintes passos:







1. Limpe e seque a área a ser reparada.
2. Corte o remendo de PVC fornecido ao tamanho adequado.
3. Utilize a cola (não incluída) para revestir um dos lados do remendo que acabou de cortar. Certifique-se que a cola está distribuída de forma uniforme.
4. Aguarde 30 segundos e depois cole o remendo que cortou sobre a área danificada.
5. Alise qualquer bolha de ar que possa ter ficado aprisionada por baixo e pressione firmemente durante dois minutos.
6. O produto está novamente pronto a usar. Repita este processo caso ocorram novas fugas.
7. Aguarde 30 minutos antes de encher.

# RESOLUÇÃO DE PROBLEMAS

A Bestway esforça-se por fornecer os spas mais livres de problemas do mercado. Se tiver quaisquer problemas, não hesite em contactar a Bestway ou o seu revendedor autorizado. Seguem-se algumas dicas úteis para o ajudar a diagnosticar e rectificar algumas fontes de problemas.

Problemas	Causas Possíveis	Soluções
A bomba não funciona	<ul style="list-style-type: none"> <li>- Falha de energia</li> <li>- GFCI avariado</li> </ul>	<ul style="list-style-type: none"> <li>- Verifique a fonte de alimentação</li> <li>- Para obter assistência, visite a secção de apoio no nosso sítio da internet: <a href="http://www.bestwaycorp.com">www.bestwaycorp.com</a></li> </ul>
Bomba não aquecendo apropriadamente	<ul style="list-style-type: none"> <li>- A temperatura definida é muito baixa</li> <li>- Cartucho de Filtro Sujo</li> <li>- O disjuntor térmico é activado</li> <li>- O spa não está coberto</li> <li>- Sistema de aquecimento falhou</li> </ul>	<ul style="list-style-type: none"> <li>- Configure para uma temperatura mais elevada, consulte a secção do funcionamento da bomba</li> <li>- Limpe/substitua o Cartucho de Filtro, consulte a secção de limpeza e substituição do cartucho de filtro</li> <li>- Adicione água nos níveis especificados</li> <li>- Desligue a bomba e coloque o tampão num local seco e fresco. E só volte a reiniciar a bomba quando a temperatura da água alcance os 35°C (95°F) ou inferior</li> <li>- Prenda a cobertura</li> <li>- Para obter assistência, visite a secção de apoio no nosso sítio da internet: <a href="http://www.bestwaycorp.com">www.bestwaycorp.com</a></li> </ul>
O Sistema Massage não funciona	<ul style="list-style-type: none"> <li>- A Bomba de Ar está a sobreaquecer</li> <li>- O Spa Massage pára automaticamente</li> <li>- A bomba de ar está avariada</li> </ul>	<ul style="list-style-type: none"> <li>- Desligue a bomba e aguarde duas horas até que esta arrefeça. Insira a ficha e pressione o Botão do Sistema massage</li> <li>- Pressione o Botão do Sistema massage para reactivar</li> <li>- Para obter assistência, visite a secção de apoio no nosso sítio da internet: <a href="http://www.bestwaycorp.com">www.bestwaycorp.com</a></li> </ul>
Os adaptadores da bomba não estão nivelados com os adaptadores do spa	<ul style="list-style-type: none"> <li>- Uma característica do PVC é que muda de forma, o que é normal</li> </ul>	<ul style="list-style-type: none"> <li>- Eleve a bomba com madeira ou outro tipo de material isolador para nivelar os adaptadores da bomba com os adaptadores do spa</li> </ul>
Fugas na piscina do spa	<ul style="list-style-type: none"> <li>- O spa está rasgado ou furado</li> <li>- A válvula de ar está solta</li> </ul>	<ul style="list-style-type: none"> <li>- Utilize o remendo de reparação fornecido</li> <li>- Recorrendo a água ensaboadada, cubra a válvula de ar para verificar se há fuga de ar, se existir uma fuga, utilize a chave fornecida para apertar a válvula de ar, seguindo os seguintes passos:             <ol style="list-style-type: none"> <li>1. Desencher o SPA.</li> <li>2. Com uma mão, segure a parte de trás da válvula de ar a partir da parte interior da parede do spa, e rode a chave no sentido dos ponteiros do relógio.</li> </ol> </li> </ul>
A água não está limpa	<ul style="list-style-type: none"> <li>- Tempo de filtração insuficiente</li> <li>- Cartucho de Filtro Sujo</li> <li>- Manutenção inadequada da água</li> </ul>	<ul style="list-style-type: none"> <li>- Aumente o tempo de filtração</li> <li>- Limpe/substitua o Cartucho de Filtro (consulte a secção Limpeza e Substituição do Cartucho de Filtro)</li> <li>- Consulte as instruções do fabricante do químico</li> </ul>
O painel de controlo não está a funcionar	<ul style="list-style-type: none"> <li>- O painel de controlo tem uma função de bloqueio automático, que é ativado após 5 minutos de inatividade. O ecrã LED tem um ícone: . Se o ícone de bloqueio estiver destacado, o painel de controlo está bloqueado</li> <li>- O painel de controlo não está ativo</li> </ul>	<ul style="list-style-type: none"> <li>- Para desbloquear o painel de controlo, pressione o botão  durante 3 segundos</li> <li>- Pressione o botão ligar/desligar durante 2 segundos. Se o painel de controlo não desbloquear, reinicie a bomba - desligue e ligue a bomba. Se o problema persistir, Para obter assistência, visite a secção de apoio no nosso sítio da internet: <a href="http://www.bestwaycorp.com">www.bestwaycorp.com</a></li> </ul>
O teste GFCI falhou	O seu spa tem um defeito.	Para obter assistência, visite a secção de apoio no nosso sítio da internet: <a href="http://www.bestwaycorp.com">www.bestwaycorp.com</a>
Que tipo de químicos devem ser utilizados para a manutenção da água?	Por favor contacte o seu fornecedor local de químicos para mais informações sobre a manutenção química. Preste atenção às instruções químicas do fabricante.	
Existe uma fuga de água nos adaptadores entre a bomba e o spa	<ul style="list-style-type: none"> <li>- Faltam vedações no interior dos adaptadores da bomba.</li> <li>- As vedações não estão na posição correta.</li> <li>- As vedações estão danificadas.</li> <li>- Os adaptadores não estão corretamente apertados.</li> </ul>	<ul style="list-style-type: none"> <li>- Insira os tampões nas portas do spa para evitar a fuga de água e desligue a bomba. Certifique-se de que as vedações estão no lugar.</li> <li>- Se as vedações não estiverem na posição correta, abra as engrenagens e coloque-as na posição correta.</li> <li>- Se as vedações estiverem danificadas, devem ser substituídas.</li> <li>- Se as vedações estiverem na posição correta, os adaptadores não estão apertados corretamente. Ligue a bomba ao spa, aperte manualmente os adaptadores e remova os tampões das portas do spa. Em caso de fugas, aperte o adaptador até pararem.</li> </ul>

# CÓDIGOS DE ERRO

CAUSAS	MOTIVOS	SOLUÇÕES
<p>Os sensores de fluxo de água funcionam sem necessidade de pressionar o botão do filtro ou do aquecimento.</p> 	<ol style="list-style-type: none"> <li>As bandeiras dos sensores de fluxo de água não recuaram para a posição correcta</li> <li>Os sensores de fluxo de água estão avariados</li> </ol>	<ol style="list-style-type: none"> <li>Desligue a ficha cuidadosamente, bata no lado da bomba mas não de forma violenta, e volte a ligar</li> <li>Para obter assistência, visite a secção de apoio no nosso sítio da internet: <a href="http://www.bestwaycorp.com">www.bestwaycorp.com</a></li> </ol>
<p>Depois de começar ou durante as funções de filtragem e/ou aquecimento, os sensores de fluxo de água não detectam o fluxo de água.</p> 	<ol style="list-style-type: none"> <li>Esqueceu-se de remover os 3 tampões do interior da piscina</li> <li>Os cartuchos dos filtros estão sujos</li> <li>Active o filtro ou o sistema de calor e coloque a mão em frente do tubo de saída no interior da piscina, para verificar se consegue sentir a água a fluir             <ol style="list-style-type: none"> <li>Caso não haja fluxo de água, significa que a bomba de água está avariada</li> <li>A água flui mas o alarme  aparece. Os sensores de fluxo de água estão avariados</li> </ol> </li> <li>Bloqueio de filtro.</li> <li>Tubos dobrados ou débito de água insuficiente através dos tubos de plástico do revestimento.</li> <li>Os filtros de resíduos estão obstruídos: os filtros de resíduos podem ficar obstruídos pela água dura devido à acumulação de calcário.</li> <li>Anilhas deterioradas. As anilhas das uniões do spa podem estar deterioradas ou gastas.</li> </ol>	<ol style="list-style-type: none"> <li>Remova as 3 tampas antes de aquecer, consulte a secção Montagem no Manual do Utilizador</li> <li>Remova o conjunto de filtro do interior da piscina e pressione o botão do filtro ou do aquecimento. Se não surgir nenhum alarme, limpe ou troque os cartuchos do filtro e instale o conjunto de filtro no interior da piscina.</li> <li>Para obter assistência, visite a secção de apoio no nosso sítio da internet: <a href="http://www.bestwaycorp.com">www.bestwaycorp.com</a></li> <li>Limpe o filtro e verifique se existem danos. Substitua ou reinstale, conforme necessário. Para obter assistência, visite a secção de apoio no nosso sítio da internet: <a href="http://www.bestwaycorp.com">www.bestwaycorp.com</a></li> <li>Verifique a ligação do spa para ver se os tubos estão dobrados. Para obter assistência, visite a secção de apoio no nosso sítio da internet: <a href="http://www.bestwaycorp.com">www.bestwaycorp.com</a></li> <li>Esvazie o spa e coloque uma mangueira de jardim no interior dos tubos para lavar os resíduos. Para garantir a remoção de todos os resíduos, efetue a operação pelo exterior e o interior do spa. Para obter assistência, visite a secção de apoio no nosso sítio da internet: <a href="http://www.bestwaycorp.com">www.bestwaycorp.com</a>. Utilize uma escova de dentes para remover os resíduos persistentes.</li> <li>Verifique as anilhas das uniões para deteção de danos. Desaperte as uniões e remova as anilhas para inspeção adicional. Para obter assistência, visite a secção de apoio no nosso sítio da internet: <a href="http://www.bestwaycorp.com">www.bestwaycorp.com</a></li> </ol>
<p>O termómetro da bomba indica que a temperatura da água é inferior a 40°F (4°C).</p> 	<ol style="list-style-type: none"> <li>A temperatura da água é inferior a 40°F (4°C)</li> <li>Se a temperatura da água for superior a 44,6°F (7°C), significa que o termómetro da bomba está avariado</li> </ol>	<ol style="list-style-type: none"> <li>O spa não foi concebido para funcionar com água a temperaturas inferiores a 40°F (4°C). Desligue a bomba e reinicie apenas quando a temperatura da água alcançar os 43°F (6°C).</li> <li>Para obter assistência, visite a secção de apoio no nosso sítio da internet: <a href="http://www.bestwaycorp.com">www.bestwaycorp.com</a></li> </ol>
<p>O termómetro da bomba indica que a temperatura da água é superior a 119°F (48°C).</p> 	<ol style="list-style-type: none"> <li>A temperatura da água é superior a 119°F (48°C)</li> <li>A temperatura ambiente está acima de 104°F (40°C) ou o spa está exposto à luz solar direta por um período prolongado.</li> <li>Se a temperatura da água for inferior a 113°F (45°C), significa que o termómetro da bomba está avariado</li> </ol>	<ol style="list-style-type: none"> <li>O spa não foi concebido para funcionar com água a temperaturas superiores a 104°F (40°C). Desligue a bomba e reinicie apenas quando a temperatura da água alcançar os 100°F (38°C) ou inferior.</li> <li>Desconecte o plugue, desconecte a bomba e drene o spa. Após 15 minutos, reconecte a bomba, reconecte o plugue e reinicie a função de aquecimento. Se o alarme reaparecer, considere mover o spa para outro local sem luz solar direta.</li> <li>Para obter assistência, visite a secção de apoio no nosso sítio da internet: <a href="http://www.bestwaycorp.com">www.bestwaycorp.com</a></li> </ol>
<p>As ligações do termómetro da bomba estão com problemas.</p> 	<ol style="list-style-type: none"> <li>Os conectores do termómetro da bomba não funcionam devidamente</li> <li>O termómetro da bomba está avariado</li> </ol>	<p>Para obter assistência, visite a secção de apoio no nosso sítio da internet: <a href="http://www.bestwaycorp.com">www.bestwaycorp.com</a></p>
<p>Corte do disjuntor térmico.</p> 	<ol style="list-style-type: none"> <li>A temperatura ambiente é superior a 122°F (50°C) ou a bomba está directamente sob luz solar.</li> <li>O disjuntor térmico está avariado.</li> </ol>	<ol style="list-style-type: none"> <li>Desligue a bomba e coloque o tampão num local seco e fresco. Só deve reiniciar a bomba quando a temperatura da água alcance os 93,2°F (34°C) ou inferior.</li> <li>Para obter assistência, visite a secção de apoio no nosso sítio da internet: <a href="http://www.bestwaycorp.com">www.bestwaycorp.com</a></li> </ol>



For support please visit us at:  
[bestwaycorp.com/support](http://bestwaycorp.com/support)

**©2021 Bestway Inflatables & Material Corp.**

All rights reserved/Tous droits réservés/Todos los derechos reservados/Alle Rechte vorbehalten/Tutti i diritti riservati

Trademarks used in some countries under license from/

Marques utilisées dans certains pays sous la licence de/

Marcas comerciales utilizadas en algunos países bajo la licencia de/

Die Warenzeichen werden in einigen Ländern verwendet unter Lizenz der/

Marchi utilizzati in alcuni paesi concessi in licenza a

**Bestway Inflatables & Material Corp., Shanghai, China**

Manufactured, distributed and represented in the European Union by/

Fabriqués, distribués et représentés dans l'Union Européenne par/Fabricado, distribuido y representado en la Unión Europea por/

Hergestellt, vertrieben und in der Europäischen Union vertreten von/Prodotto, distribuito e rappresentato nell'Unione Europea da

**Bestway (Europe) S.r.l., Via Resistenza, 5, 20098 San Giuliano Milanese (Milano), Italy**

Distributed in North America by/Distribués en Amérique du Nord par/Distribuido en Norteamérica por

**Bestway (USA) Inc., 3411 E. Harbour Drive, Phoenix, Arizona 85034, United States of America**

Tel: +86 21 69135588 (For U.S. and Canada)

Distributed in Latin America by/Distribués en Amérique latine par/Distribuido en Latinoamérica por/Distribuido na América Latina por

**Bestway Central & South America Ltda, Salar Ascotan 1282, Parque Enea, Pudahuel, Santiago, Chile**

Distributed in Australia & New Zealand by **Bestway Australia Pty Ltd, Unit 2/98-104 Carnarvon St Silverwater, NSW 2128, Australia**

Tel: Australia: (+61) 29 0371 388; New Zealand: 0800 142 101

Distributed in United Kingdom by **Bestway Corp UK Ltd, 8 Wentworth Road, Heathfield Industrial Estate, Newton Abbot, Devon, TQ12 6TL**

Exported by/Exporté par/Exportado por/Exportiert von/Esportato da

**Bestway (Hong Kong) International Ltd./Bestway Enterprise Company Limited**

Suite 713, 7/Floor, East Wing, Tsim Sha Tsui Centre, 66 Mody Road, Kowloon, Hong Kong

[www.bestwaycorp.com](http://www.bestwaycorp.com)